



FORÇADO AÇO

DISTRIBUIÇÃO, CORTE E DOBRA

Nossa Empresa

NOSSA EMPRESA

Fundada no ano de 1.989, a FORÇA DO AÇO está estrategicamente localizada em Campo Mourão, o maior entrocamento rodoviário do estado do Paraná. Em mais de 30 anos de atuação no fornecimento de ferro e aço e serviços para diversos segmentos, é referência em todo território nacional, fruto de técnicas modernas de trabalho e logística de distribuição.

Visão

Ser referência na distribuição de ferro e aço em todo o Brasil, mantendo padrão de qualidade, e alcançar a excelência na prestação de serviços.

Missão

Alcançar a excelência, oferecendo sempre os melhores produtos e serviços é a maior motivação da FORÇA DO AÇO.



FORÇA DO AÇO
DISTRIBUIÇÃO, CORTE E DOBRA



BARRA CHATA

BITOLA	PESO TEÓRICO KG/M	BITOLA	PESO TEÓRICO KG/M	BITOLA	PESO TEÓRICO KG/M	BITOLA	PESO TEÓRICO KG/M
2,50MM X 1/2"	0,25	1/4 X 1.3/4"	2,22	1/2 X 2.1/2"	6,33	3/4 X 1.1/2"	5,7
1/8 X 3/8"	0,24	1/4 X 2"	2,53	1/2 X 3"	7,6	3/4 X 1.3/4"	6,65
1/8 X 1/2"	0,32	1/4 X 2.1/2"	3,17	1/2 X 3.1/2"	8,86	3/4 X 2"	7,6
1/8 X 5/8"	0,4	1/4 X 3"	3,8	1/2 X 4"	10,13	3/4 X 2.1/2"	9,5
1/8 X 3/4"	0,48	1/4 X 4"	5,06	1/2 X 5"	12,66	3/4 X 3"	11,4
1/8 X 7/8"	0,55	1/4 X 5"	6,33	1/2 X 6"	15,19	3/4 X 3.1/2"	13,29
1/8 X 1"	0,63	1/4 X 6"	7,6	5/8 X 1"	3,17	3/4 X 4"	15,19
1/8 X 1.1/4"	0,79	5/16 X 1"	1,58	5/8 X 1.1/4"	3,96	3/4 X 5"	18,99
1/8 X 1.1/2"	0,95	5/16 X 1.1/4"	1,98	5/8 X 1.1/2"	4,75	3/4 X 6"	22,79
1/8 X 1.3/4"	1,11	5/16 X 1.1/2"	2,37	5/8 X 1.3/4"	5,54	1 X 1.1/4"	6,33
1/8 X 2"	1,27	5/16 X 1.3/4"	2,77	5/8 X 2"	6,33	1 X 1.1/2"	7,6
1/8 X 2.1/2"	1,59	5/16 X 2"	3,17	5/8 X 2.1/2"	7,92	1 X 1.3/4"	8,86
1/8 X 3"	1,9	5/16 X 2.1/2"	3,96	5/8 X 3"	9,5	1 X 2"	10,13
1/8 X 4"	2,54	5/16 X 3"	4,75	5/8 X 3.1/2"	11,08	1 X 2.1/2"	12,66
3/16 X 1/2"	0,47	5/16 X 3.1/2"	5,54	5/8 X 4"	12,67	1 X 3"	15,19
3/16 X 5/8"	0,59	5/16 X 4"	6,33	5/8 X 5"	15,83	1 X 4"	20,26
3/16 X 3/4"	0,71	5/16 X 5"	7,92	5/8 X 6"	19	1 X 5"	25,32
3/16 X 7/8"	0,83	5/16 X 6"	9,5	3/4 X 1"	3,8	1 X 6"	30,39
3/16 X 1"	0,95	3/8 X 1"	1,9	3/4 X 1.1/4"	4,75		
3/16 X 1.1/4"	1,19	3/8 X 1.1/4"	2,38				
3/16 X 1.1/2"	1,42	3/8 X 1.1/2"	2,85				
3/16 X 1.3/4"	1,66	3/8 X 1.3/4"	3,33				
3/16 X 2"	1,9	3/8 X 2"	3,8				
3/16 X 2.1/2"	2,37	3/8 X 2.1/2"	4,75				
3/16 X 3"	2,85	3/8 X 3"	5,7				
3/16 X 4"	3,8	3/8 X 3.1/2"	6,65				
3/16 X 5"	4,75	3/8 X 4"	7,6				
1/4 X 1/2"	0,63	3/8 X 5"	9,5				
1/4 X 5/8"	0,79	3/8 X 6"	11,4				
1/4 X 3/4"	0,95	1/2 X 1"	2,53				
1/4 X 7/8"	1,11	1/2 X 1.1/4"	3,17				
1/4 X 1"	1,27	1/2 X 1.1/2"	3,8				
1/4 X 1.1/4"	1,58	1/2 X 1.3/4"	4,43				
1/4 X 1.1/2"	1,9	1/2 X 2"	5,06				

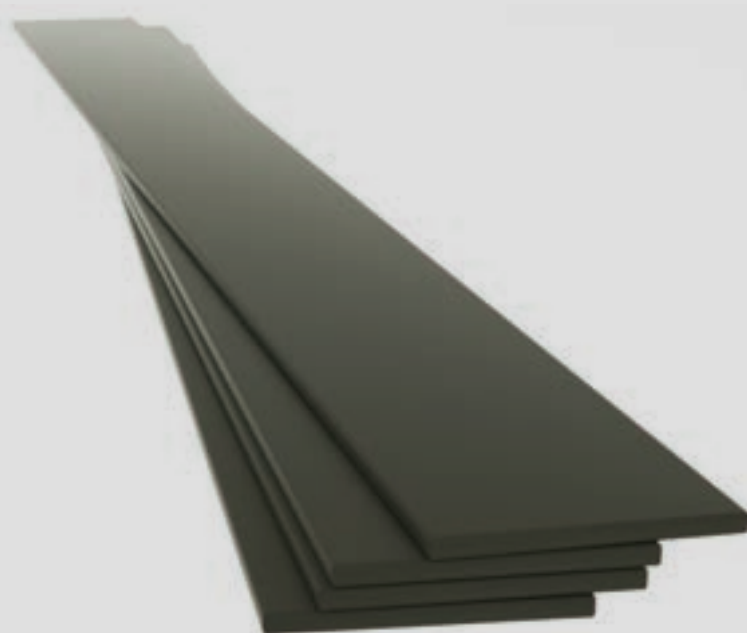

BARRA QUADRADA LAMINADA

BITOLA		PESO TEÓRICO KG/M
POL.	MM	
1/4"	6,35	0,32
5/16"	7,94	0,5
3/8"	9,53	0,71
1/2"	12,7	1,27
5/8"	15,88	1,98
3/4"	19,05	2,85
7/8"	22,23	3,88
1"	25,4	5,06
1.1/8"	28,58	6,4
1.1/4"	31,75	7,91
1.5/16"	33,34	8,73
1.1/2"	38,1	11,4
1.3/4"	44,45	15,51
2"	50,8	20,24
2.1/4"	57,15	25,62
2.3/8"	60,33	28,54
2.1/2"	63,5	31,62
2.5/8"	66,68	34,87
2.3/4"	69,85	38,27
2.7/8"	73,03	41,82
3"	76,2	45,54
3.1/8"	79,38	49,41
3.1/4"	82,55	53,44
3.1/2"	88,9	61,98
3.3/4"	95,25	71,15
4"	101,6	81,03

BARRA QUADRADA TREFILADA

BITOLA		PESO TEÓRICO KG/M
POL.	MM	
3/16"	4,76	0,18
1/4"	6,35	0,32
5/16"	7,94	0,5
3/8"	9,53	0,71
7/16"	11,11	0,97
1/2"	12,7	1,27
9/16"	14,29	1,6
5/8"	15,88	1,98
11/16"	17,46	2,39
3/4"	19,05	2,85
*	20	3,14
13/16"	20,64	3,34
7/8"	22,23	3,88
15/16"	23,81	4,45
*	24	4,55
1"	25,4	5,06
1.1/16"	26,99	5,72
1.1/8"	28,58	6,4
1.1/4"	31,75	7,91
1.3/8"	34,93	9,57
1.1/2"	38,1	11,39
1.5/8"	41,28	13,96
1.3/4"	44,45	15,5



BARRA REDONDA LAMINADA

BITOLA		PESO TEÓRICO KG/M
POL.	MM	
1/4"	6,35	0,25
5/16"	7,94	0,39
3/8"	9,53	0,56
1/2"	12,7	0,99
9/16"	14,29	1,26
5/8"	15,88	1,56
11/16"	17,46	1,88
3/4"	19,05	2,24
7/8"	22,23	3,05
1"	25,4	3,98
1.1/8"	28,58	5,04
1.1/4"	31,75	6,22
1.5/16"	33,34	6,85
1.3/8"	34,93	7,52
1.7/16"	36,51	8,22
1.1/2"	38,1	8,95
1.9/16"	39,69	9,71
1.5/8"	41,28	10,5
1.3/4"	44,45	12,18
1.13/16"	46,04	13,06
1.7/8"	47,63	13,98
2"	50,8	15,91
2.1/16"	52,39	16,92
2.1/8"	53,98	17,96
2.1/4"	57,15	20,14
2.5/16"	58,74	21,28
2.3/8"	60,33	22,43
2.7/16"	61,91	23,63
2.1/2"	63,5	24,86
2.9/16"	65,09	26,11
2.5/8"	66,68	27,4
2.3/4"	69,85	30,08
2.7/8"	73,03	32,87
3"	76,2	35,79

BITOLA		PESO TEÓRICO KG/M
POL.	MM	
3.1/8"	79,38	38,84
3.1/4"	82,55	42,01
3.1/2"	88,9	48,73
3.3/4"	95,25	55,88
4"	101,6	63,58
4.1/4"	107,95	71,78
4.1/2"	114,3	80,47
4.3/4"	120,65	89,66
5"	127	99,8
*	130	104,17
5.1/4"	133,35	109,5
5.1/2"	139,7	120,2
5.3/4"	146,05	131,4
6"	152,4	143,1
6.1/4"	158,75	155,2
6.1/2"	165,1	167,9
6.3/4"	171,45	181,1
7"	177,8	194,7
7.1/2"	190,5	223,8
8"	203,2	254,6
8.1/2"	215,9	287,4
9"	228,6	322,1
9.1/2"	241,3	359
10"	254	397,8

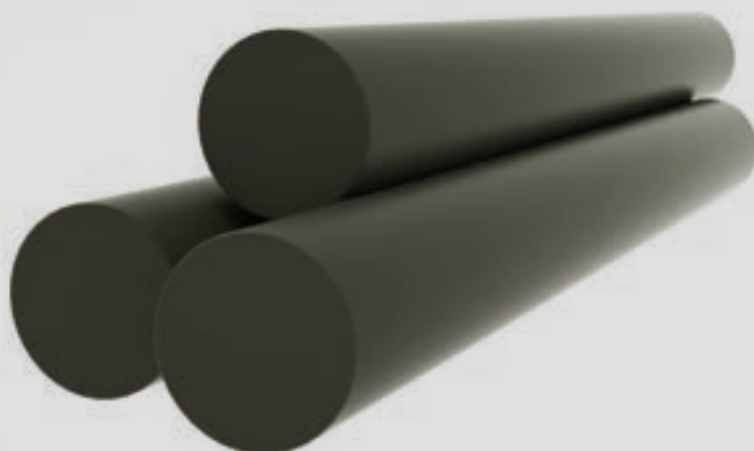

BARRA REDONDA TREFILADA

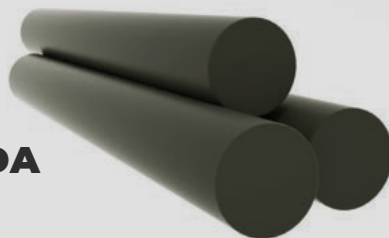

FORÇADO AÇO
DISTRIBUIÇÃO, CORTE E DOBRA

BITOLA		TOLERÂNCIA	PESO TEÓRICO KG/M	BITOLA		TOLERÂNCIA	PESO TEÓRICO KG/M	BITOLA		TOLERÂNCIA	PESO TEÓRICO KG/M
POL.	MM	MM		POL.	MM	MM		POL.	MM	MM	
*	3	+0,00/-0,08	0,056	*	14,5	+0,00/-0,11	1,296	*	35	+0,00/-0,16	7,554
1/8"	3,18	+0,00/-0,08	0,062	*	14,6	+0,00/-0,11	1,315	*	35,4	+0,00/-0,16	7,728
5/32"	3,97	+0,00/-0,08	0,097	*	14,85	+0,00/-0,11	1,36	*	35,7	+0,00/-0,16	7,86
*	4	+0,00/-0,08	0,1	*	15	+0,00/-0,11	1,388	*	36	+0,00/-0,16	7,99
3/16"	4,76	+0,00/-0,08	0,14	5/8"	15,88	+0,00/-0,11	1,555	*	37	+0,00/-0,16	8,44
*	5	+0,00/-0,08	0,154	*	16	+0,00/-0,11	1,578	1.1/2"	38,1	+0,00/-0,16	8,951
*	5,5	+0,00/-0,08	0,187	*	16,8	+0,00/-0,11	1,741	*	38,5	+0,00/-0,16	9,034
*	6	+0,00/-0,08	0,236	*	16,9	+0,00/-0,11	1,761	*	40	+0,00/-0,16	9,865
1/4"	6,35	+0,00/-0,09	0,249	*	17	+0,00/-0,11	1,782	1.5/8"	41,28	+0,00/-0,16	10,49
*	6,9	+0,00/-0,09	0,294	*	17,2	+0,00/-0,11	1,824	1.3/4"	44,45	+0,00/-0,16	12,184
*	7	+0,00/-0,09	0,302	11/16"	17,46	+0,00/-0,11	1,879	*	45	+0,00/-0,16	12,485
*	7,2	+0,00/-0,09	0,32	*	17,9	+0,00/-0,11	1,975	*	46	+0,00/-0,16	13,05
*	7,5	+0,00/-0,09	0,347	*	18	+0,00/-0,11	1,998	1.7/8"	47,63	+0,00/-0,16	13,97
5/16"	7,94	+0,00/-0,09	0,388	*	18,2	+0,00/-0,13	2,04	*	50	+0,00/-0,16	15,414
*	8	+0,00/-0,09	0,395	3/4"	19,05	+0,00/-0,13	2,237	2"	50,8	+0,00/-0,19	15,913
*	8,3	+0,00/-0,09	0,425	*	20	+0,00/-0,13	2,466	*	52	+0,00/-0,19	16,67
*	8,35	+0,00/-0,09	0,43	*	20,2	+0,00/-0,13	2,52	2.1/8"	53,98	+0,00/-0,19	17,962
*	8,4	+0,00/-0,09	0,435	13/16"	20,64	+0,00/-0,13	2,63	*	55	+0,00/-0,19	18,65
*	8,9	+0,00/-0,09	0,49	*	20,9	+0,00/-0,13	2,693	2.1/4"	57,15	+0,00/-0,19	20,137
*	9	+0,00/-0,09	0,499	*	21	+0,00/-0,13	2,721	*	60	+0,00/-0,19	22,195
*	9,2	+0,00/-0,09	0,522	*	22	+0,00/-0,13	2,984	2.3/8"	60,33	+0,00/-0,19	22,436
3/8"	9,53	+0,00/-0,09	0,559	7/8"	22,23	+0,00/-0,13	3,044	2.1/2"	63,5	+0,00/-0,19	24,86
*	9,8	+0,00/-0,09	0,592	*	23,15	+0,00/-0,13	3,304	*	65	+0,00/-0,19	26,049
*	10	+0,00/-0,09	0,616	15/16"	23,81	+0,00/-0,13	3,495	2.5/8"	66,68	+0,00/-0,19	27,409
*	10,2	+0,00/-0,11	0,641	*	25	+0,00/-0,13	3,853	2.3/4"	69,85	+0,00/-0,19	30,081
*	10,5	+0,00/-0,11	0,68	*	25,3	+0,00/-0,13	3,956	*	70	+0,00/-0,19	30,21
*	10,8	+0,00/-0,11	0,699	1"	25,4	+0,00/-0,13	3,977	2.7/8"	73,03	+0,00/-0,19	32,878
*	10,9	+0,00/-0,11	0,733	*	26	+0,00/-0,13	4,168	*	75	+0,00/-0,19	34,68
*	11	+0,00/-0,11	0,746	1.1/16"	26,99	+0,00/-0,13	4,491	*	76	+0,00/-0,19	35,611
7/16"	11,11	+0,00/-0,11	0,761	*	28	+0,00/-0,13	4,833	3"	76,2	+0,00/-0,19	35,799
*	11,3	+0,00/-0,11	0,787	1.1/8"	28,58	+0,00/-0,13	5,04	*	80	+0,00/-0,19	39,46
*	11,8	+0,00/-0,11	0,858	*	29,3	+0,00/-0,13	5,294	3.1/4"	82,55	+0,00/-0,19	41,88
*	12	+0,00/-0,11	0,888	*	30	+0,00/-0,13	5,549	*	85	+0,00/-0,19	44,55
*	12,2	+0,00/-0,11	0,918	1.3/16"	30,16	+0,00/-0,16	5,608	3.1/2"	88,9	+0,00/-0,19	48,68
1/2"	12,7	+0,00/-0,11	0,994	*	30,3	+0,00/-0,16	5,662	*	90	+0,00/-0,19	50
*	13	+0,00/-0,11	1,04	1.1/4"	31,75	+0,00/-0,16	6,216	*	95	+0,00/-0,19	55,65
*	14	+0,00/-0,11	1,208	*	32	+0,00/-0,16	6,313	*	100	+0,00/-0,19	61,8
9/16"	14,29	+0,00/-0,11	1,257	1.5/16"	33,34	+0,00/-0,16	6,858	4"	101,6	+0,00/-0,19	63,58
*	14,35	+0,00/-0,11	1,27	1.3/8"	34,93	+0,00/-0,16	7,51				

BARRAS



BARRA SEXTAVADA TREFILADA

BITOLA		PESO TEÓRICO KG/M	BITOLA		PESO TEÓRICO KG/M
POL.	MM		POL.	MM	
3/16"	4,76	0,15	1"	25,4	4,39
1/4"	6,35	0,27	1.1/16"	26,99	4,95
5/16"	7,94	0,43	1.1/8"	28,58	5,55
3/8"	9,53	0,62	1.3/16"	30,16	6,18
7/16"	11,11	0,84	1.1/4"	31,75	6,85
1/2"	12,7	1,1	1.5/16"	33,34	7,56
9/16"	14,29	1,39	1.3/8"	34,93	8,29
5/8"	15,88	1,71	1.7/16"	36,51	9,06
11/16"	17,46	2,07	1.1/2"	38,1	9,87
3/4"	19,05	2,47	1.5/8"	41,28	11,57
13/16"	20,64	2,89	1.3/4"	44,45	13,43
7/8"	22,23	3,36	2"	50,8	17,54
15/16"	23,81	3,85			

CANTONEIRA ABAS IGUAIS

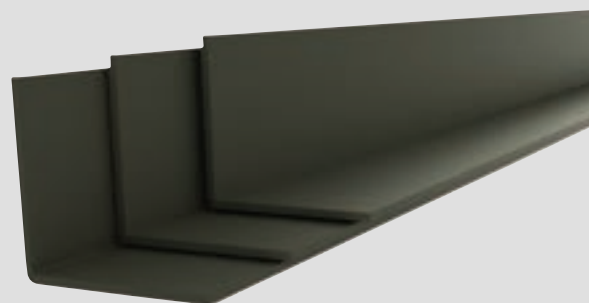

BITOLA	PESO TEÓRICO KG/M	BITOLA	PESO TEÓRICO KG/M	BITOLA	PESO TEÓRICO KG/M	BITOLA	PESO TEÓRICO KG/M
1/8 X 1/2"	0,55	3/16 X 1.3/4"	3,15	1/4 X 4"	9,81	3/8 X 6"	22,2
1/8 X 5/8"	0,71	3/16 X 2"	3,63	5/16 X 2"	5,83	1/2 X 3"	13,9
1/8 X 3/4"	0,87	3/16 X 2.1/2"	4,52	5/16 X 2.1/2"	7,44	1/2 X 4"	19,05
1/8 X 7/8"	1,04	3/16 X 3"	5,52	5/16 X 3"	9,07	1/2 X 5"	24,1
1/8 X 1"	1,19	1/4 X 1"	2,29	5/16 X 3.1/2"	10,7	1/2 X 6"	29,2
1/8 X 1.1/4"	1,5	1/4 X 1.1/4"	2,86	5/16 X 4"	12,19	5/8 X 4"	23,42
1/8 X 1.1/2"	1,83	1/4 X 1.1/2"	3,48	3/8 X 2"	6,99	5/8 X 5"	29,8
1/8 X 1.3/4"	2,14	1/4 X 1.3/4"	4,12	3/8 X 2.1/2"	8,78	5/8 X 6"	36
1/8 X 2"	2,46	1/4 X 2"	4,75	3/8 X 3"	10,72	5/8 X 8"	48,78
3/16 X 1"	1,73	1/4 X 2.1/2"	6,1	3/8 X 3.1/2"	12,5	3/4 X 5"	35,1
3/16 X 1.1/4"	2,2	1/4 X 3"	7,3	3/8 X 4"	14,58	3/4 X 6"	42,7
3/16 X 1.1/2"	2,68	1/4 X 3.1/2"	8,63	3/8 X 5"	18,3	3/4 X 8"	57,8



PERFIL LAMINADO TEE

BITOLA		PESO TEÓRICO KG/M	BITOLA		PESO TEÓRICO KG/M
POL.	MM		POL.	MM	
3/4"	2,50 X 19,05	0,69	1/8 X 1.1/2"	3,18 X 38,10	1,82
1/8 X 5/8"	3,18 X 15,88	0,71	3/16 X 1.1/4"	4,76 X 31,75	2,16
1/8 X 3/4"	3,18 X 19,05	0,86	3/16 X 1.1/2"	4,76 X 38,10	2,65
1/8 X 7/8"	3,18 X 22,23	0,99	3/16 X 2"	4,76 X 50,80	3,62
1/8 X 1"	3,18 X 25,40	1,18	1/4 X 1.1/2"	6,35 X 38,10	3,42
1/8 X 1.1/4"	3,18 X 31,75	1,5	1/4 X 2"	6,35 X 50,80	4,74

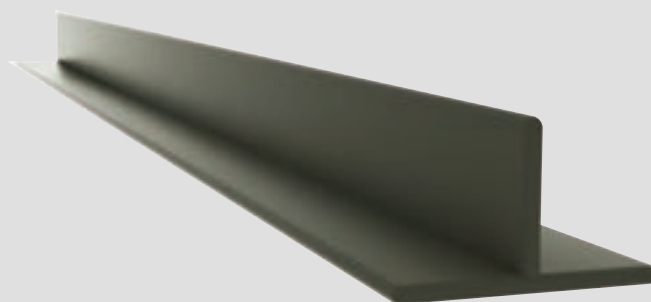

CHAPAS

CHAPA FINA A FRIO

BITOLA MSG	ESPESSURA MM	PESO TEÓRICO KG/M ²
30	0,3	2,4
28	0,38	3,04
26	0,45	3,6
24	0,6	4,8
22	0,75	6
20	0,9	7,2
19	1,06	8,48
18	1,2	9,6
16	1,5	12
14	1,9	15,2

CHAPA FINA A QUENTE

BITOLA MSG	ESPESSURA MM	PESO TEÓRICO KG/M ²
16	1,5	12
15	1,8	14,4
14	2	16
13	2,25	18
12	2,65	21,2
11	3	24
10	3,35	26,8
9	3,75	30
8	4,25	34
7	4,5	36
3/16"	4,75	38
*	5	40

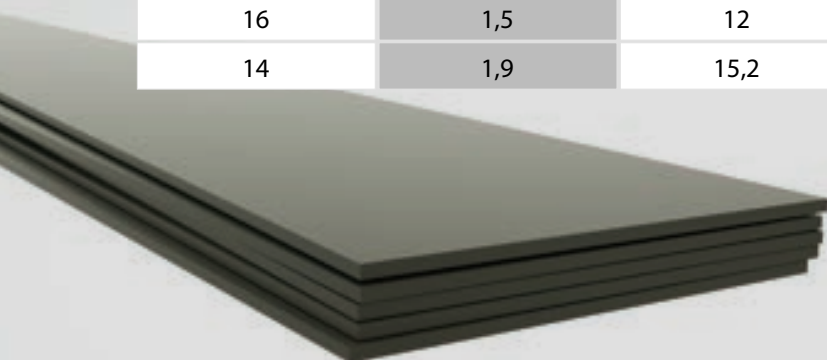

CHAPA GROSSA

ESPESSURA		PESO TEÓRICO KG/M	ESPESSURA		PESO TEÓRICO KG/M
POL.	MM		POL.	MM	
1/4"	6,3	49,39	1.1/4"	31,5	247,27
5/16"	8	62,72	1.1/2"	37,5	299
3/8"	9,5	74,48	1.3/4"	44,45	350
1/2"	12,5	99	2"	50	392,5
5/8"	16	125,44	2.1/2"	63	494,55
3/4"	19	149,5	3"	75	588,1
7/8"	22,4	175,84	3.1/2"	88,9	697,8
1"	25	198	4"	100	785

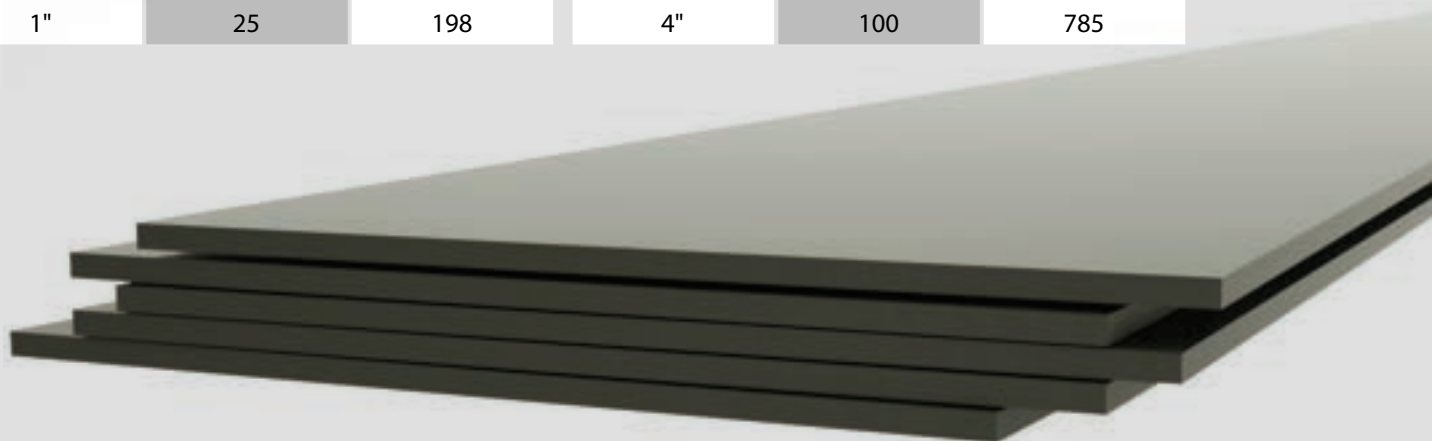

CHAPA PARA PISO (XADREZ)

ESPESSURA		PESO TEÓRICO KG/M
POL.	MM	
1/8"	3	27
3/16"	4,75	41
1/4"	6,3	54
5/16"	8	68
3/8"	9,5	81

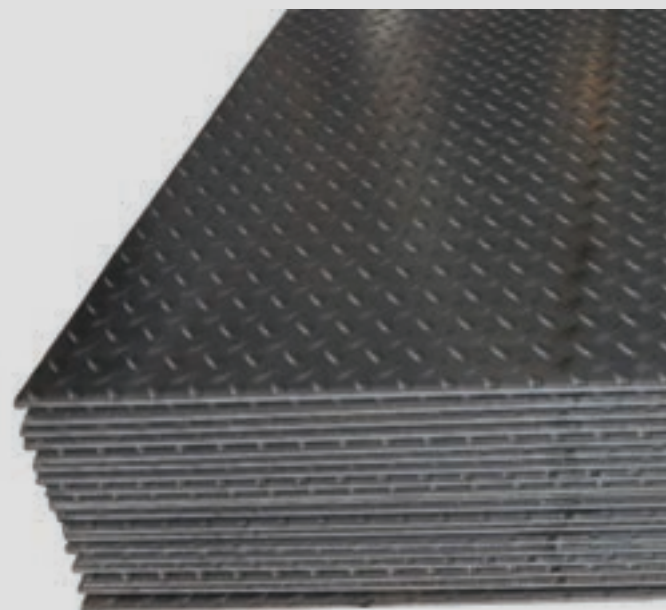

CHAPA ZINCADA (GALVANIZADA)

BITOLA MSG	ESPESSURA MM	PESO TEÓRICO KG/M ²
32	0,3	2,4
30	0,35	2,8
28	0,43	3,44
26	0,5	4
24	0,65	5,2
22	0,8	6,4
20	0,95	7,6
19	1,11	8,88
18	1,25	10
16	1,55	12,4
14	1,95	15,6
13	2,3	18,4
12	2,7	21,6

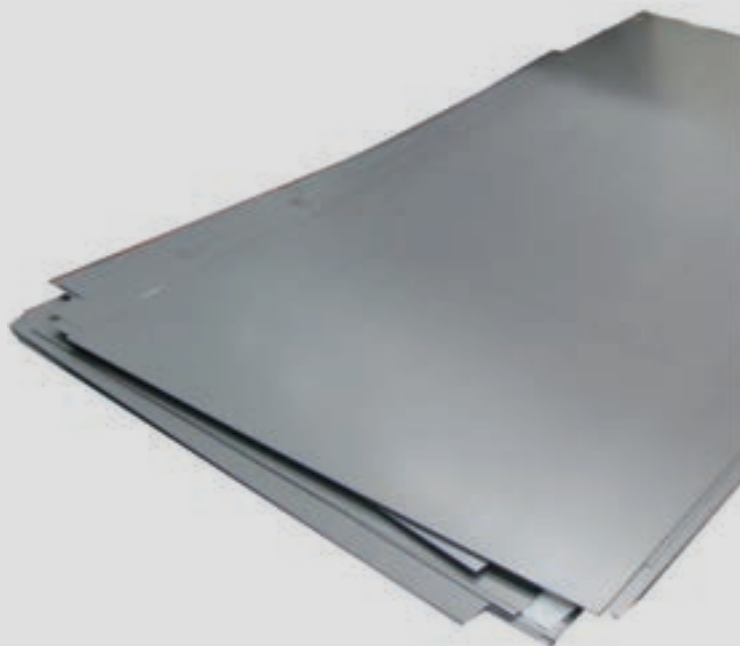

CHAPA EXPANDIDA

ESPESSURA		MALHA		PESO TEÓRICO KG/M ²
POL.	MM	B MM	A MM	
1/8"	3	75	38	4,2
3/16"	4,75	100	40	8
1/4"	6,3	100	40	11

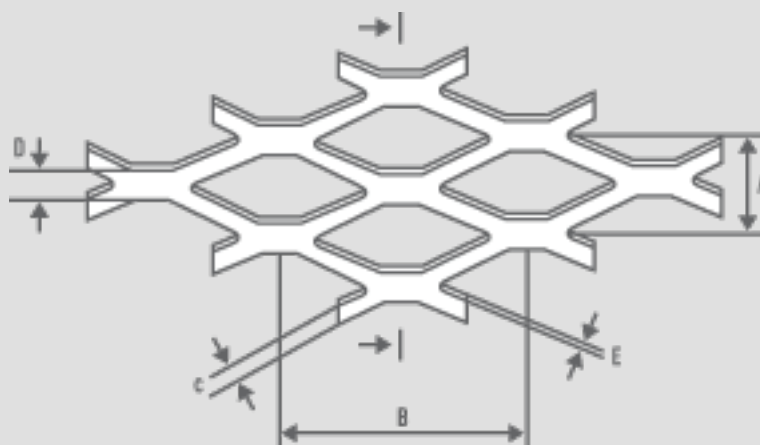

A = centro da malha menor
 B = centro da malha maior
 C = cordão da malha
 D = cruzeta
 E = espessura

CHAPAS COM FURO OBLONGOS



CHAPAS COM FURO REDONDO



CHAPAS COM FURO QUADRADO

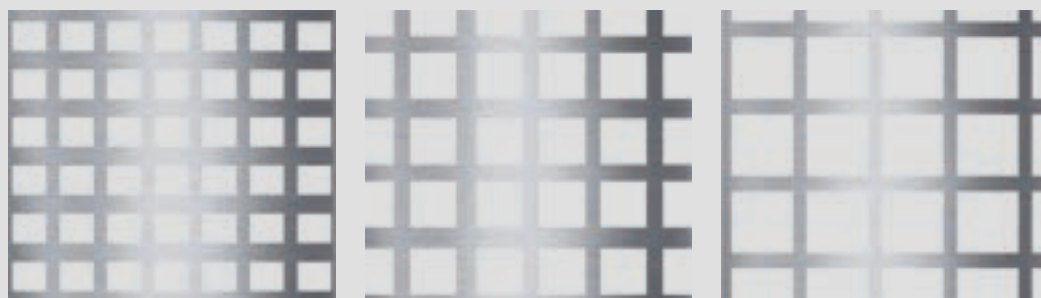

CHAPA ESTENDIDA

2,00m x 1,00m
Chapa 3/16 - Chapa 1/4



CHAPA COM TEXTURA

Chapa Xadrex



RAIADA 24

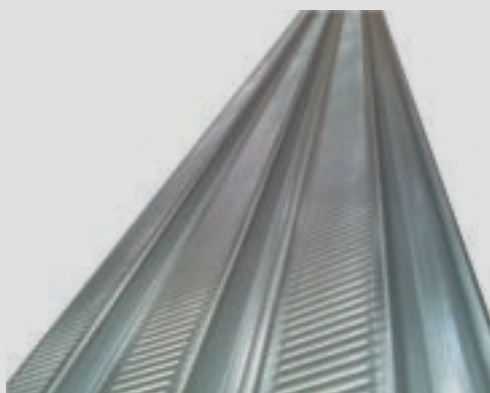

ONDULADA

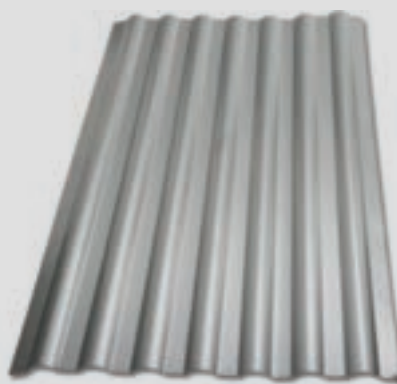

PERFIL U - ABAS INCLINADAS

BITOLA (H X B)		ALMA	ESPESSURA DA ALMA (E)		PESO TEÓRICO KG/M
POL.	MM		MM	POL.	
3" X 1.1/2"	76,20 X 35,81	1 ^a	4,32	0,17	6,11
3" X 1.1/2"	76,20 X 38,05	2 ^a	6,55	0,258	7,44
4" X 1.5/8"	101,60 X 40,23	1 ^a	4,67	0,183	7,95
4" X 1.5/8"	101,60 X 41,83	2 ^a	6,27	0,246	9,3
6" X 2"	152,40 X 48,80	1 ^a	5,08	0,2	12,2
6" X 2"	152,40 X 51,70	2 ^o	7,98	0,314	15,6
8" X 2.1/4"	203,20 X 57,15	1 ^a	5,59	0,22	17,1
8" X 2.1/4"	203,20 X 57,15	2 ^a	7,7	0,303	20,5
10" X 2.5/8"	254,00 X 66,68	1 ^a	6,1	0,24	22,7
10" X 2.5/8"	254,00 X 66,68	2 ^a	9,63	0,379	29,8
12" X 3"	304,80 X 76,20	1 ^a	7,11	0,28	30,7
12" X 3"	304,80 X 76,20	2 ^a	9,83	0,387	37,2
15" X 3.3/8"	381,00 X 85,73	1 ^a	10,2	0,4	50,4
15" X 3.3/8"	381,00 X 85,73	2 ^a	10,7	0,422	52,1

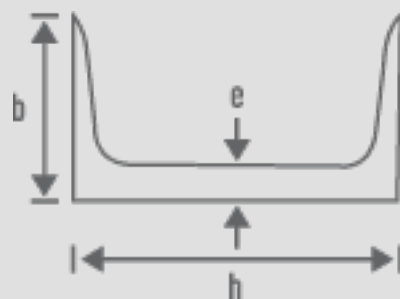

h = largura do perfil
e = espessura da alma
b = altura do perfil

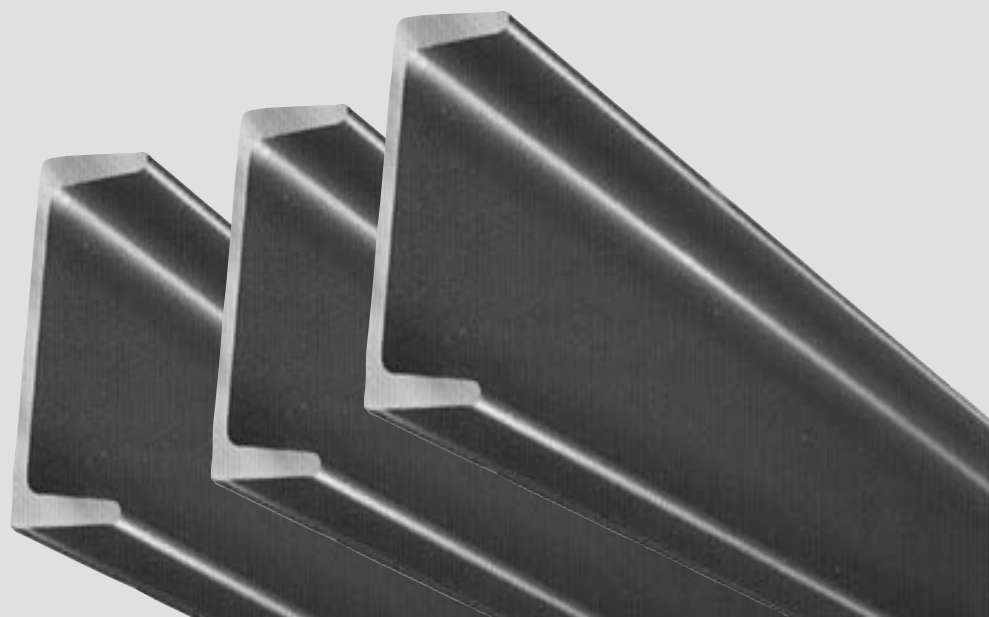

PERFIL I - ABAS INCLINADAS

BITOLA (H X B)		ALMA	ESPESSURA DA ALMA (E)		PESO TEÓRICO KG/M
POL.	MM		MM	POL.	
3" X 2.3/8"	76,20 X 59,20	1 ^a	4,32	0,17	8,48
3" X 2.3/8"	76,20 X 61,20	2 ^a	6,38	0,251	9,68
4" X 2.5/8"	101,60 X 67,60	1 ^a	4,9	0,193	11,46
4" X 2.5/8"	101,60 X 69,20	2 ^a	6,43	0,253	12,65
5" X 3"	127,00 X 76,20	1 ^a	5,44	0,214	14,88
5" X 3"	127,00 X 79,70	2 ^a	8,81	0,347	18,2
6" X 3.3/8"	152,40 X 84,60	1 ^o	5,89	0,232	18,6
6" X 3.3/8"	152,40 X 87,50	2 ^a	8,71	0,343	22

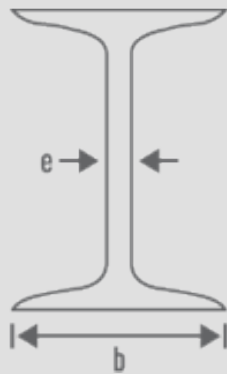

b = largura do perfil
e = espessura da alma
h = altura do perfil

PERFIL U ESTRUTURAL - ENRIJECIDO

DIMENSÃO				S	P	JX	WX	IX	EY	JY	WY	IY
H	B	D	E=R	CM ²	KG/M	CM ⁴	CM ³	CM	CM	CM ⁴	CM ³	CM
MM	MM	MM	MM									
50	25	10	2	2	1,57	7,4	2,96	1,92	0,92	1,68	1,06	0,92
			2,25	2,33	1,83	8,4	3,36	1,9	0,92	1,87	1,18	0,9
			2,65	2,64	2,07	9,28	3,71	1,88	0,91	2,02	1,28	0,88
			3	2,92	2,3	10,04	4,01	1,85	0,91	2,15	1,35	0,86
75	40	15	2	3,23	2,54	28,46	7,59	2,97	1,5	7,43	2,97	1,52
			2,25	3,81	2,99	33,01	8,8	2,94	1,49	8,52	3,4	1,5
			2,65	4,37	3,43	37,25	9,93	2,92	1,49	9,5	3,78	1,48
			3	4,9	3,85	41,18	10,98	2,9	1,48	10,38	4,13	1,46
100	50	17	2	4,16	3,27	66,05	13,2	3,98	1,78	14,87	4,61	1,89
			2,25	4,93	3,87	77,21	15,44	3,96	1,77	17,21	5,33	1,87
			2,65	5,67	4,45	87,8	17,56	3,94	1,77	19,36	5,99	1,85
			3	6,39	5,02	97,83	19,57	3,91	1,76	21,35	6,59	1,83

PERFIL U ESTRUTURAL - ENRIJECIDO

DIMENSÃO				S	P	JX	WX	IX	EY	JY	WY	IY
H	B	D	E=R	CM ²	KG/M	CM ⁴	CM ³	CM	CM	CM ⁴	CM ³	CM
MM	MM	MM	MM									
127	50	17	2	4,68	3,67	115,45	18,18	4,97	1,59	16,17	4,74	1,86
			2,25	5,54	4,35	135,33	21,31	4,94	1,59	18,71	5,48	1,84
			2,65	6,39	5,01	154,31	24,3	4,92	1,58	21,07	6,17	1,82
			3	7,21	5,66	172,4	27,15	4,89	1,58	23,24	6,79	1,8
150	60	20	2	5,61	4,4	195,38	26,05	5,9	1,92	28,36	6,95	2,25
			2,25	6,66	5,23	229,93	30,66	5,88	1,91	33,03	8,08	2,23
			2,65	7,69	6,04	263,19	35,09	5,85	1,91	37,42	9,15	2,21
			3	8,7	6,83	295,19	39,36	5,82	1,91	41,53	10,14	2,18
200	75	25	2,65	10,08	7,92	614,2	61,42	7,8	2,32	77,8	15,02	2,78
			3	11,44	8,98	691,93	69,19	7,78	2,32	86,9	16,76	2,76
			3,35	12,76	10,02	766,84	76,68	7,75	2,31	95,46	18,4	2,73
			3,75	14,07	11,04	839,21	83,92	7,72	2,31	103,55	19,94	2,71
			4,25	15,35	12,05	909,31	90,93	7,7	2,3	111,2	21,4	2,69
			4,75	17,26	13,55	1012,8	101,28	7,66	2,3	123,17	23,67	2,67

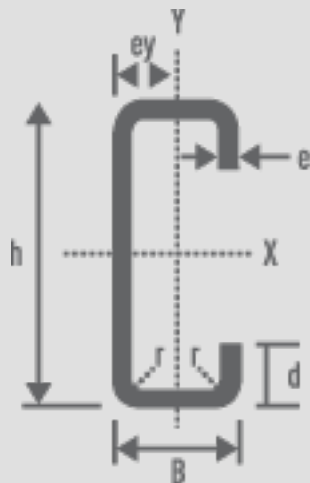

S = área de seção
P = peso estimado por metro
Jx = momento de inércia (eixo X)
Wx = módulo de resistência (eixo X)
ix = raio de giro (eixo X)
ey = distância da linha neutra
Jy = momento de inércia (eixo Y)
Wy = módulo de resistência (eixo Y)
iy = raio de giro (eixo Y)

PERFIL U ESTRUTURAL - SIMPLES

DIMENSÃO			S	P	JX	WX	IX	EY	JY	WY	IY
H	B	E=R	CM ²	KG/M	CM ⁴	CM ³	CM	CM	CM ⁴	CM ³	CM
MM	MM	MM									
50	25	2	1,75	1,38	6,66	2,6	1,94	0,71	1,07	0,6	0,78
		2,25	2,07	1,62	7,7	3	1,92	0,73	1,26	0,71	0,77
		2,65	2,38	1,86	8,66	3,4	1,9	0,75	1,43	0,82	0,77
		3	2,67	2,1	9,55	3,8	1,88	0,77	1,59	0,92	0,77
75	38	2	2,8	2,2	25,1	6,6	2,99	1,12	4,55	1,58	1,27
		2,25	3,32	2,61	29,43	7,8	2,97	1,14	5,37	1,88	1,27
		2,65	3,84	3,01	33,56	8,9	2,95	1,16	6,15	2,17	1,26
		3	4,35	3,41	37,49	9,9	2,93	1,18	6,91	2,45	1,26
		4,75	6,48	5,09	52,75	14	2,85	1,27	10	3,66	1,24
		2	3,27	2,57	49,01	9,8	3,86	0,97	4,99	1,65	1,23

PERFIL U ESTRUTURAL - SIMPLES

DIMENSÃO			S	P	JX	WX	IX	EY	JY	WY	IY
H	B	E=R	CM ²	KG/M	CM ⁴	CM ³	CM	CM	CM ⁴	CM ³	CM
MM	MM	MM									
100	40	2,25	3,89	3,06	57,67	11,5	3,84	0,99	5,89	1,96	1,22
		2,65	4,51	3,54	65,99	13,1	3,82	1,01	6,76	2,26	1,22
		3	5,11	4,01	73,99	14,7	3,8	1,03	7,61	2,56	1,22
		4,75	7,67	6,02	105,9	21,1	3,71	1,11	11,09	3,84	1,2
100	50	2	3,65	2,87	58,15	11,6	3,98	1,34	9,24	2,52	1,58
		2,25	4,35	3,41	68,55	13,7	3,96	1,36	10,94	3	1,58
		2,65	5,04	3,95	78,6	15,7	3,94	1,38	12,59	3,48	1,58
		3	5,71	4,48	88,29	17,6	3,92	1,4	14,2	3,94	1,57
		4,75	8,63	6,77	127,5	25,4	3,84	1,48	20,89	5,84	1,55
127	50	2	4,17	3,27	101,3	15,9	4,92	1,19	9,94	2,61	1,54
		2,25	4,97	3,9	119,6	18,8	4,9	1,2	11,78	3,1	1,53
		2,65	5,76	4,52	137,5	21,6	4,88	1,22	13,57	3,59	1,53
		3	6,53	5,13	154,8	24,3	4,86	1,24	15,32	4,08	1,53
		4,75	9,91	7,78	225,9	35,5	4,77	1,32	22,66	6,16	1,51
150	50	2	4,6	3,61	149,9	19,9	5,7	1,08	10,42	2,66	1,5
		2,25	5,49	4,31	177,4	23,6	5,68	1,1	12,35	3,17	1,49
		2,65	6,37	5	204,1	27,2	5,65	1,12	14,24	3,67	1,49
		3	7,23	5,68	230,1	30,6	5,63	1,13	16,08	4,16	1,49
		4,75	11,01	8,64	338	45	5,54	1,21	23,84	6,3	1,47
200	50	2	5,55	4,39	299,3	29,9	7,33	0,91	11,2	2,74	1,41
		2,25	6,63	5,2	354,9	35,4	7,31	0,93	13,28	3,26	1,41
		2,65	7,7	6,04	409,3	40,9	7,28	0,95	15,32	3,78	1,41
		3	8,75	6,87	462,4	46,2	7,26	0,96	17,31	4,29	1,4
		4,75	13,39	10,51	686,2	68,6	7,15	1,04	25,76	6,51	1,38

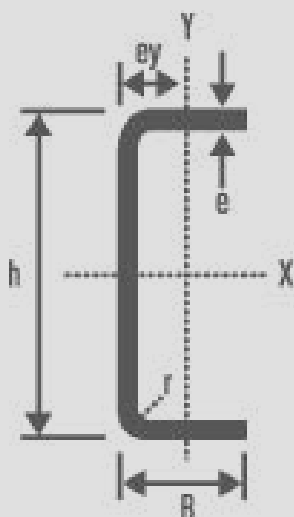

- S = área de secção
- P = peso estimado por metro
- Jx = momento de inércia (eixo X)
- Wx = módulo de resistência (eixo X)
- ix = raio de giro (eixo X)
- ey = distância da linha neutra
- Jy = momento de inércia (eixo Y)
- Wy = módulo de resistência (eixo Y)
- iy = raio de giro (eixo Y)

PERFIL W ABAS PARALELAS – PERFIL (W) H - HP

BITOLA MM X KG/M	PESO TEÓRICO KG/M	D MM	Bf MM	H MM	ESPESSURA	
					T _w MM	T _r MM
W 150 X 22,50	22,5	152	152	139	5,8	6,6
W 150 X 29,80	29,8	157	153	138	6,6	9,3
W 150 X 37,10	37,1	162	154	139	8,1	11,6
W 200 X 35,90	35,9	201	165	181	6,2	10,2
W 200 X 41,70	41,7	205	166	181	7,2	11,8
W 200 X 46,10	46,1	203	203	181	7,2	11
W 200 X 52,00	52	206	204	181	7,9	12,6
HP 200 X 53,00	53	204	207	181	11,3	11,3
W 200 X 59,00	59	210	205	182	9,1	14,2
W 200 X 71,00	71	216	206	181	10,2	17,4
W 200 X 86,00	86	222	209	181	13	20,6
HP 250 X 62,00	62	246	256	225	10,5	10,7
W 250 X 73,00	73	253	254	225	8,6	14,2
W 250 X 80,00	80	256	255	225	9,4	15,6
HP 250 X 85,00	85	254	260	225	14,4	14,4
W 250 X 89,00	89	260	256	225	10,7	17,3
W 250 X 101,00	101	264	257	225	11,9	19,6
W 250 X 115,00	115	269	259	225	13,5	22,1
HP 310 X 79,00	79	299	306	277	11	11
HP 310 X 93,00	93	303	308	277	13,1	13,1
W 310 X 97,00	97	308	305	277	9,9	15,4
W 310 X 107,00	107	311	306	277	10,9	17
HP 310 X 110,00	110	308	310	277	15,4	15,5
W 310 X 117,00	117	314	307	277	11,9	18,7
HP 310 X 125,00	125	312	312	277	17,4	17,4
W 360 X 91,00	91	353	254	288	9,5	16,4
W 360 X 101,00	101	357	255	286	10,5	18,3
W 360 X 110,00	110	360	256	288	11,4	19,9
W 360 X 122,00	122	363	257	288	13	21,7

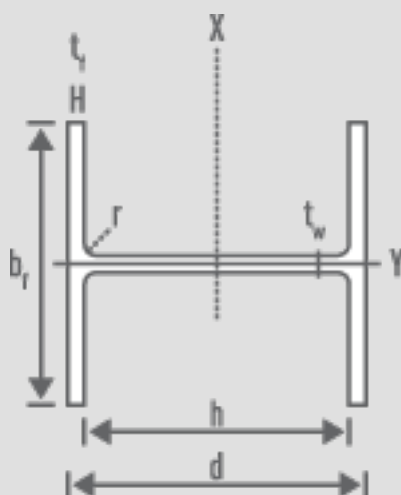

d = altura do perfil
 h = altura interna
 b_f = largura da aba do perfil
 t_f = espessura da aba
 t_w = espessura da alma
 r = raio de concordância

PERFIL W ABAS PARALELAS – PERFIL (W) I

BITOLA MM X KG/M	PESO TEÓRICO KG/M	D MM	Bf MM	H MM	ESPESSURA	
					Tw MM	Tf MM
W 150 X 13,00	13	148	100	138	4,3	4,9
W 150 X 18,00	18	153	102	139	5,8	7,1
W 150 X 24,00	24	160	102	139	6,6	10,3
W 200 X 15,00	15	200	100	190	4,3	5,2
W 200 X 19,30	19,3	203	102	190	5,8	6,5
W 200 X 22,50	22,5	206	102	190	6,2	8
W 200 X 26,60	26,6	207	133	190	5,8	8,4
W 200 X 31,30	31,3	210	134	190	6,4	10,2
W 250 X 17,90	17,9	251	101	240	4,8	5,3
W 250 X 22,30	22,3	254	102	240	5,8	6,9
W 250 X 25,30	25,3	257	102	240	6,1	8,4
W 250 X 28,40	28,4	260	102	240	6,4	10
W 250 X 32,70	32,7	258	146	240	6,1	9,1
W 250 X 38,50	38,5	262	147	240	6,6	11,2
W 250 X 44,80	44,8	266	148	240	7,6	13
W 310 X 21,00	21	303	101	292	5,1	5,7
W 310 X 23,80	23,8	305	101	292	5,6	6,7
W 310 X 28,30	28,3	309	102	291	6	8,9
W 310 X 32,70	32,7	313	102	291	6,6	10,8
W 310 X 38,70	38,7	310	165	291	5,8	9,7
W 310 X 44,50	44,5	313	166	291	6,6	11,2
W 310 X 52,00	52	317	167	291	7,6	13,2
W 360 X 32,90	32,9	349	127	332	5,8	8,5
W 360 X 39,00	39	353	128	332	6,5	10,7
W 360 X 44,00	44	352	171	332	6,9	9,8
W 360 X 51,00	51	355	171	332	7,2	11,6
W 360 X 57,80	57,8	358	172	332	7,9	13,1
W 360 X 64,00	64	347	203	320	7,7	13,5
W 360 X 72,00	72	350	204	320	8,6	15,1
W 360 X 79,00	79	354	205	320	9,4	16,8
W 410 X 38,80	38,8	399	140	381	6,4	8,8
W 410 X 46,10	46,1	403	140	381	7	11,2
W 410 X 53,00	53	403	177	381	7,5	10,9
W 410 X 60,00	60	407	178	381	7,7	12,8
W 410 X 67,00	67	410	179	381	8,8	14,4
W 410 X 75,00	75	413	180	381	9,7	16
W 410 X 85,00	85	417	181	381	10,9	18,2
W 460 X 52,00	52	450	152	428	7,6	10,8
W 460 X 60,00	60	455	153	428	8	13,3
W 460 X 68,00	68	459	154	428	9,1	15,4

PERFIL W ABAS PARALELAS – PERFIL (W) I

BITOLA MM X KG/M	PESO TEÓRICO KG/M	D MM	B _f MM	H MM	ESPESSURA	
					T _w MM	T _f MM
W 460 X 74,00	74	457	190	428	9	14,5
W 460 X 82,00	82	460	191	428	9,9	16
W 460 X 89,00	89	463	192	428	10,5	17,7
W 460 X 97,00	97	466	193	428	11,4	19
W 460 X 106,00	106	469	194	428	12,6	20,6
W 530 X 66,00	66	525	165	502	8,9	11,4
W 530 X 72,00	72	524	207	502	9	10,9
W 530 X 74,00	74	529	166	502	9,7	13,6
W 530 X 82,00	82	528	209	501	9,5	13,3
W 530 X 85,00	85	535	166	502	10,3	16,5
W 530 X 92,00	92	533	209	502	10,2	15,6
W 530 X 101,00	101	537	210	502	10,9	17,4
W 530 X 109,00	109	539	211	501	11,6	18,8
W 610 X 101,00	101	603	228	573	10,5	14,9
W 610 X 113,00	113	608	228	573	11,2	17,3
W 610 X 125,00	125	612	229	573	11,9	19,6
W 610 X 140,00	140	617	230	573	13,1	22,2
W 610 X 155,00	155	611	324	573	12,7	19
W 610 X 174,00	174	616	325	573	14	21,6

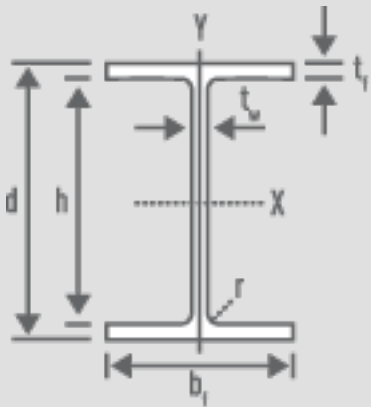

d = altura do perfil
h = altura interna
b_f = largura da aba do perfil
t_f = espessura da aba
t_w = espessura da alma
r = raio de concordância

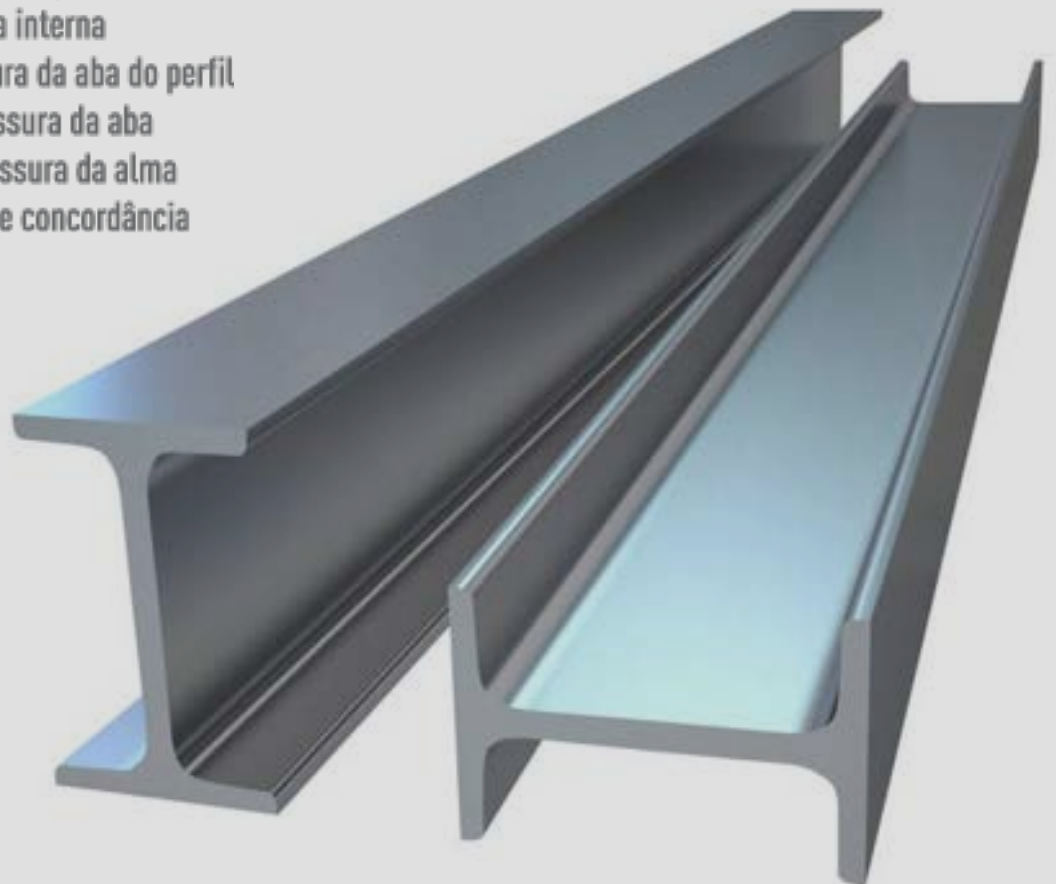

TUBO INDUSTRIAL QUADRADO

PESO TEÓRICO KG/M																					
BITOLA MM	ESPESSURA MM																				
	0,90	1,06	1,20	1,50	1,90	2,00	2,25	2,65	3,00	3,35	3,75	4,25	4,50	4,75	5,00	5,40	5,60	6,30	7,30	8,00	9,50
15 X 15	0,4	0,47	0,53	0,65																	
16 X 16	0,43	0,5	0,57	0,7																	
20 X 20	0,54	0,64	0,72	0,88	1,08	1,13															
25 X 25	0,68	0,8	0,9	1,12	1,4	1,47	1,64	1,9	2,13												
30 X 30	0,83	0,97	1,09	1,35	1,7	1,78	1,99	2,32	2,6	2,87	3,18										
35 X 35	0,97	1,13	1,28	1,59	1,99	2,09	2,34	2,73	3,07	3,4	3,76										
40 X 40	1,11	1,3	1,47	1,82	2,29	2,41	2,69	3,15	3,54	3,92	4,35	4,88	5,14	5,39							
50 X 50		1,63	1,84	2,29	2,89	3,03	3,4	3,98	4,48	4,97	5,53	6,21	6,55	6,88	7,05	7,54	7,79	8,62			
60 X 60		1,96	2,22	2,76	3,48	3,66	4,1	4,81	5,42	6,02	6,7	7,54	7,96	8,37	8,78	9,43	9,75	10,86			
63,5 X 63,5			2,35	2,93	3,69	3,88	4,35	5,1	5,74	6,39	7,11	8,01	8,45	8,89	9,33	10,02	10,36	11,55			
70 X 70			2,6	3,23	4,08	4,29	4,81	5,64	6,36	7,07	7,87	8,87	9,37	9,86	10,35	11,12	11,5	12,83			
80 X 80				3,7	4,67	4,91	5,51	6,47	7,29	8,12	9,05	10,2	10,78	11,35	11,91	12,81	13,26	14,81			
90 X 90				4,17	5,27	5,54	6,22	7,3	8,23	9,17	10,22	11,53	12,19	12,83	13,48	14,5	15,01	16,78	19,26	20,97	24,55
100 X 100					6,17	6,92	8,13	9,17	10,22	11,4	12,87	13,59	14,32	15,04	16,19	16,77	18,75	21,55	23,48	27,53	
110 X 110					6,79	7,63	8,96	10,11	11,26	12,57	14,2	15	15,81	16,61	17,89	18,52	20,73	23,84	25,98	30,5	
120 X 120					7,42	8,33	9,79	11,05	12,31	13,75	15,53	16,41	17,3	18,18	19,58	20,27	22,7	26,12	28,49	33,48	
130 X 130					8,04	9,04	10,62	11,99	13,36	14,92	16,86	17,82	18,78	19,74	21,27	22,03	24,67	28,41	30,99	36,45	
150 X 150							12,28	13,87	15,46	17,27	19,52	20,64	21,76	22,87	24,65	25,54	28,62	32,98	36,01	42,41	
160 X 160							13,11	14,81	16,51	18,45	20,85	22,05	23,25	24,44	26,34	27,29	30,59	35,27	38,51	45,38	
170 X 170							13,94	15,75	17,56	19,62	22,18	23,46	24,73	26,01	28,03	29,04	32,57	37,55	41,02	48,36	
175 X 175							14,35	16,22	18,08	20,21	22,85	24,17	25,48	26,79	28,88	29,92	33,55	38,7	42,27	49,84	

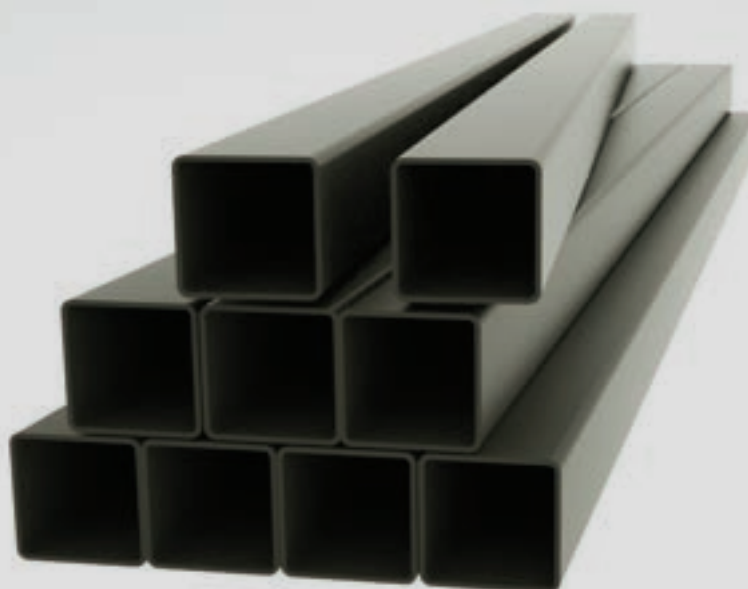

TUBO INDUSTRIAL REDONDO

PESO TEÓRICO KG/M																						
DIÂMETRO		ESPESSURA MM																				
POL.	MM	0,90	1,06	1,20	1,50	1,90	2,00	2,25	2,65	3,00	3,35	3,75	4,25	4,50	4,75	5,00	5,40	5,60	6,30	7,30	8,00	9,50
1/2"	12,7	0,26	0,3	0,34	0,41	0,51	0,53															
5/8"	15,88	0,33	0,39	0,43	0,53	0,65	0,68															
3/4"	19,05	0,4	0,47	0,53	0,65	0,8	0,84															
7/8"	22,23	0,47	0,55	0,62	0,77	0,95	1	1,46	1,28	1,42												
1"	25,4	0,54	0,64	0,72	0,88	1,1	1,15	1,64	1,49	1,66												
	26,9	0,58	0,68	0,76	0,94	1,17	1,23	1,73	1,58	1,77	1,95											
1.1/8"	28,58	0,61	0,72	0,81	1	1,25	1,31	1,75	1,7	1,89	2,09	2,3										
1.1/4"	31,75	0,68	0,8	0,9	1,12	1,4	1,47	1,81	1,9	2,13	2,35	2,59										
	33,4	0,72	0,85	0,95	1,18	1,48	1,55	1,99	2,01	2,25	2,48	2,74										
	33,7	0,73	0,85	0,96	1,19	1,49	1,56	2,17	2,03	2,27	2,51	2,77										
1.3/8"	34,93	0,76	0,89	1	1,24	1,55	1,62	2,23	2,11	2,36	2,61	2,88										
1.1/2"	38,1	0,83	0,97	1,09	1,35	1,7	1,78	2,34	2,32	2,6	2,87	3,18	3,55	3,73	3,91							
1.5/8"	41,28	0,9	1,05	1,19	1,47	1,84	1,94	2,52	2,52	2,83	3,13	3,47	3,88	4,08	4,28							
	42,4	0,92	1,08	1,22	1,51	1,9	1,99	2,56	2,6	2,91	3,23	3,57	4	4,21	4,41							
1.3/4"	44,45	0,97	1,13	1,28	1,59	1,99	2,09	2,69	2,73	3,07	3,4	3,76	4,21	4,43	4,65							
1.7/8"	47,63	1,04	1,22	1,37	1,71	2,14	2,25	3,05	2,94	3,3	3,66	4,06	4,54	4,78	5,02							
	48,3	1,05	1,23	1,39	1,73	2,17	2,28	3,22	2,98	3,35	3,71	4,12	4,62	4,86	5,1							
2"	50,8	1,11	1,3	1,47	1,82	2,29	2,41	3,4	3,15	3,54	3,92	4,35	4,88	5,14	5,39	5,65	6,05	6,24	6,91			
2.1/4"	57,15	1,25	1,47	1,66	2,06	2,59	2,72	4,1	3,56	4,01	4,44	4,94	5,54	5,84	6,14	6,43	6,89	7,12	7,9			
2.3/8"	60,33	1,32	1,55	1,75	2,18	2,74	2,88	4,81	3,77	4,24	4,7	5,23	5,87	6,19	6,51	6,82	7,31	7,55	8,39			
2.1/2"	63,5	1,39	1,63	1,84	2,29	2,89	3,03	5,51	3,98	4,48	4,97	5,53	6,21	6,55	6,88	7,21	7,74	8	8,89			
3"	76,2	1,67	1,96	2,22	2,76	3,48	3,66	6,22	4,81	5,42	6,02	6,7	7,54	7,96	8,37	8,78	9,43	9,75	10,86			
3.1/2"	88,9			2,6	3,23	4,08	4,29	6,92	5,64	6,36	7,07	7,87	8,87	9,37	9,86	10,35	11,12	11,5	12,83			
4"	101,6			2,97	3,7	4,67	4,91	7,63	6,47	7,29	8,12	9,05	10,2	10,78	11,35	11,91	12,81	13,26	14,81			
4.1/2"	114,3				4,17	5,27	5,54	8,33	7,3	8,23	9,17	10,22	11,53	12,19	12,83	13,48	14,5	15,01	16,78	19,26	20,97	24,55
5"	127				4,64	5,86	6,17	9,04	8,13	9,17	10,22	11,4	12,87	13,59	14,32	15,04	16,19	16,77	18,75	21,55	23,48	27,53
5.1/2"	139,7				5,11	6,46	6,79	9,21	8,96	10,11	11,26	12,57	14,2	15	15,81	16,61	17,89	18,52	20,73	23,84	25,98	30,5
6"	152,4				5,58	7,05	7,42	11,15	9,79	11,05	12,31	13,75	15,53	16,41	17,3	18,18	19,58	20,27	22,7	26,12	28,49	33,48
6.1/2"	165,1						8,04	1,11	10,62	11,99	13,36	14,92	16,86	17,82	18,78	19,74	21,27	22,03	24,67	28,41	30,99	36,45
6.5/8"	168,3						8,2	1,28	10,83	12,23	13,63	15,22	17,19	18,18	19,16	20,14	21,69	22,47	25,17	28,98	31,63	37,2
8"	203,2						9,92	1,37	13,11	14,81	16,51	18,45	20,85	22,05	23,25	24,44	26,34	27,29	30,59	35,27	38,51	45,38

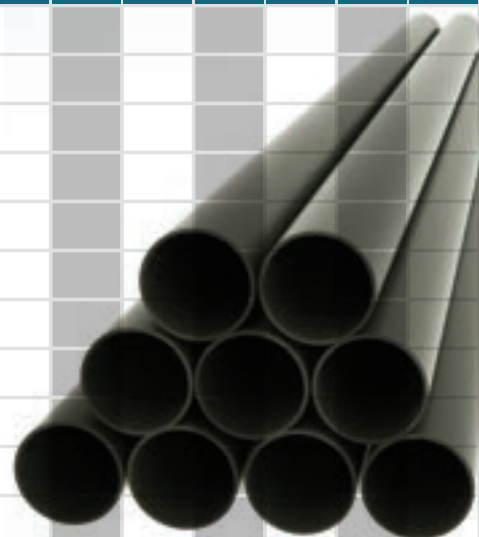

TUBOS



TUBO INDUSTRIAL RETANGULAR

PESO TEÓRICO KG/M

BITOLA MM	ESPESSURA MM																				
	0,90	1,06	1,20	1,50	1,90	2,00	2,25	2,65	3,00	3,35	3,75	4,25	4,50	4,75	5,00	5,40	5,60	6,30	7,30	8,00	9,50
30 X 20	0,68	0,8	0,9	1,12	1,4	1,47	1,64	1,9	2,13												
35 X 25	0,83	0,97	1,09	1,35	1,7	1,78	1,99	2,32	2,6												
40 X 20	0,83	0,97	1,09	1,35	1,7	1,78	1,99	2,32	2,6	2,87	3,18										
40 X 30	0,97	1,13	1,28	1,59	1,99	2,09	2,34	2,73	3,07	3,4											
50 X 20	0,97	1,13	1,28	1,59	1,99	2,09	2,34	2,73	3,07	3,4											
50 X 30	1,11	1,3	1,47	1,82	2,29	2,41	2,69	3,15	3,54	3,92	4,35	4,88	5,14	5,39							
50 X 40		1,47	1,66	2,06	2,59	2,72	3,05	3,56	4,01	4,44	4,94	5,54	5,84	6,14							
60 X 30		1,47	1,66	2,06	2,59	2,72	3,05	3,56	4,01	4,44											
60 X 40		1,63	1,84	2,29	2,89	3,03	3,4	3,98	4,48	4,97	5,53	6,21	6,55	6,88							
70 X 30		1,63	1,84	2,29	2,89	3,03	3,4	3,98	4,48	4,97	5,53	6,21	6,55	6,88							
70 X 50		1,96	2,22	2,76	3,48	3,66	4,1	4,81	5,42	6,02	6,7	7,54	7,96	8,37	8,78	9,43	9,75	10,86			
80 X 40		1,96	2,22	2,76	3,48	3,66	4,1	4,81	5,42	6,02	6,7	7,54	7,96	8,37	8,78	9,43	9,75	10,86			
80 X 50						3,97	4,46	5,22	5,89	6,54	7,29	8,21	8,66	9,11							
80 X 60				3,23	4,08	4,29	4,81	5,64	6,36	7,07	7,87	8,87	9,37	9,86							
90 X 30			2,22	2,76	3,48	3,66	4,1	4,81	5,42	6,02	6,7	7,54	7,96	8,37							
100 X 40				3,23	4,08	4,29	4,81	5,64	6,36	7,07	7,87	8,87	9,37	9,86							
100 X 50				3,47	4,37	4,6	5,16	6,05	6,83	7,59	8,46	9,54	10,07	10,6	11,13	11,97	12,38	13,82			
100 X 60				3,7	4,67	4,91	5,51	6,47	7,29	8,12	9,05	10,2	10,78	11,35	11,91	12,81	13,26	14,81			
100 X 80				4,17	5,27	5,54	6,22	7,3	8,23	9,17	10,22	11,53	12,19	12,83	13,48	14,5	15,01	16,78			
120 X 40				3,7	4,67	4,91	5,51	6,47	7,29	8,12	9,05	10,2	10,78	11,35	11,91	12,81	13,26	14,81			
120 X 60				4,17	5,27	5,54	6,22	7,3	8,23	9,17	10,22	11,53	12,19	12,83	13,48	14,5	15,01	16,78	19,26	20,97	24,55
120 X 80					5,86	6,17	6,92	8,13	9,17	10,22	11,4	12,87	13,59	14,32	15,04	16,19	16,77	18,75	21,55	23,48	27,53
120 X 100						6,79	7,63	8,96	10,11	11,26	12,57	14,2	15	15,81	16,61	17,89	18,52	20,73	23,84	25,98	30,5
140 X 60						6,17	6,92	8,13	9,17	10,22	11,4	12,87	13,59	14,32	15,04	16,19	16,77	18,75			
140 X 80						6,79	7,63	8,96	10,11	11,26	12,57	14,2	15	15,81	16,61	17,89	18,52	20,73			
150 X 50						6,17	6,92	8,13	9,17	10,22	11,4	12,87	13,59	14,32	15,04	16,19	16,77	18,75	21,55	23,48	27,53
150 X 100								10,2	11,52	12,84	14,33	16,19	17,12	18,04	18,96	20,42	21,15	23,69	27,27	29,74	34,97
160 X 80								9,79	11,05	12,31	13,75	15,53	16,41	17,3	18,18	19,58	20,27	22,7	26,12	28,49	33,48
180 X 80								10,62	11,99	13,36	14,92	16,86	17,82	18,78	19,74	21,27	22,03	24,67	28,41	30,99	36,45
200 X 100								12,28	13,87	15,46	17,27	19,52	20,64	21,76	22,87	24,65	25,54	28,62	32,98	36,01	42,41

TUBO SCH 40 E 80 - NBR 5590

SCHEDULE 40 - NORMA NBR 5590

DIÂMETRO		ESPESSURA MM	PESO TEÓRICO PRETO KG/M
POL.	MM		
1/2"	21,3	2,77	1,26
3/4"	26,7	2,87	1,68
1"	33,4	3,38	2,5
1.1/4"	42,2	3,56	3,38
1.1/2"	48,3	3,68	4,05
2"	60,3	3,91	5,43
2.1/2"	73	5,16	8,62
3"	88,9	5,49	11,28
3.1/2"	101,6	5,74	13,56
4"	114,3	6,02	16,06
5"	141,3	6,55	21,75
6"	168,3	7,11	28,23
8"	219,1	8,18	42,48
10"	273,05	9,27	60,23
12"	323,84	10,31	79,64

SCHEDULE 40 - NORMA NBR 5590

DIÂMETRO		ESPESSURA MM	PESO TEÓRICO PRETO KG/M
POL.	MM		
1/2"	21,3	3,73	1,62
3/4"	26,7	3,91	2,19
1"	33,4	4,55	3,23
1.1/4"	42,2	4,85	4,46
1.1/2"	48,3	5,08	5,4
2"	60,3	5,54	7,47
2.1/2"	73	7,01	11,4
3"	88,9	7,62	15,25
3.1/2"	101,6	8,08	18,6
4"	114,3	8,56	22,29
5"	141,3	9,52	30,92
6"	168,3	10,97	42,51
8"	219,1	12,7	64,56
10"	273,05	15,1	95,87
12"	323,84	17,47	131,88



Fórmulas Para Cálculo de Peso

BARRA REDONDA



FÓRMULA	EXEMPLO: REDONDO 1"	RESULTADO
$\frac{d \times d \times 3,1416 \times \text{Peso específico}}{4.000}$	$\frac{25,40 \times 25,40 \times 3,1416 \times 7,85}{4.000}$	3,977 kg/m

BARRA SEXTAVADA



FÓRMULA	EXEMPLO: SEXTAVADO 1"	RESULTADO
$\frac{d \times d \times 3 \times \text{Peso específico}}{3.460}$	$\frac{25,40 \times 25,40 \times 3 \times 7,85}{3.460}$	4,391 kg/m

BARRA QUADRADA



FÓRMULA	EXEMPLO: QUADRADO 1"	RESULTADO
$\frac{d \times d \times \text{Peso específico}}{1.000}$	$\frac{25,40 \times 25,40 \times 7,85}{1.000}$	5,064 kg/m

TUBO REDONDO



FÓRMULA	EXEMPLO: TUBO REDONDO 1" X 1/16"	RESULTADO
$\frac{[(de \times de \times 3,1416) - (di \times di \times 3,1416)] \times \text{Peso específico}}{4.000}$	$\frac{[(25,40 \times 25,40 \times 3,1416) - (22,22 \times 22,22 \times 3,1416)] \times 7,85}{4.000}$	0,933 kg/m

CHAPA

FÓRMULA	EXEMPLO: CHAPA DE FERRO 12,70MM	RESULTADO
Espessura x Peso específico	12,70 x 7,85	99,70 kg/m ²

BARRA CHATA

FÓRMULA	EXEMPLO: BARRA CHATA DE FERRO 1" X 1/4"	RESULTADO
$\frac{\text{Largura} \times \text{Espessura} \times \text{Peso específico}}{1.000}$	$\frac{25,40 \times 6,35 \times 7,85}{1.000}$	1,266 kg/m

Tabela de Conversão de Polegadas e Milímetros



FORÇADO AÇO
DISTRIBUIÇÃO, CORTE E DOBRA

POL.	MM	POL.	MM	POL.	MM	POL.	MM
1/32"	0,79	1.1/32"	26,19	2.1/16"	52,39	6.1/4"	158,75
1/16"	1,59	1.1/16"	26,99	2.1/8"	53,98	6.1/2"	165,1
3/32"	2,38	1.1/32"	27,78	2.3/16"	55,56	6.3/4"	171,45
1/8"	3,18	1.1/8"	28,58	2.1/4"	57,15	7"	177,8
5/32"	3,97	1.5/32"	29,37	2.5/16"	58,74	7.1/2"	190,5
3/16"	4,76	1.3/16"	30,16	2.3/8"	60,33	8"	203,2
JUL/32	5,56	1.7/32"	30,96	2.7/16"	61,91	8.1/2"	215,9
1/4"	6,35	1.1/4"	31,75	2.1/2"	63,5	9"	228,6
9/32"	7,14	1.9/32"	32,54	2.9/16"	65,09	9.1/2"	241,3
5/16"	7,94	1.5/16"	33,34	2.5/8"	66,68	10"	254
11/32"	8,73	1.11/32"	34,13	2.11/16"	68,26	10.1/2"	266,7
3/8"	9,53	1.3/8"	34,93	2.3/4"	69,85	11"	279,4
13/32"	10,32	1.13/32"	35,72	2.13/16"	71,44	11.1/2"	292,1
7/16"	11,11	1.7/16"	36,51	2.7/8"	73,03	12"	304,8
15/32"	11,91	1.15/32"	37,31	2.15/16"	74,61	12.1/2"	317,5
1/2"	12,7	1.1/2"	38,1	3"	76,2	13"	330,2
17/32"	13,49	1.17/32"	38,89	3.1/8"	79,38	13.1/2"	342,9
9/16"	14,29	1.9/16"	39,69	3.1/4"	82,55	14"	355,6
19/32"	15,08	1.19/32"	40,48	3.3/8"	85,73	14.1/2"	368,3
5/8"	15,88	1.5/8"	41,28	3.1/2"	88,9	15"	381
21/32"	16,67	1.21/32"	42,07	3.5/8"	92,08	15.1/2"	393,7
11/16"	17,46	1.11/16"	42,86	3.3/4"	95,25	16"	406,4
23/32"	18,26	1.23/32"	43,66	3.7/8"	98,43	16.1/2"	419,1
3/4"	19,05	1.3/4"	44,45	4"	101,6	17"	431,8
25/32"	19,84	1.25/32"	45,24	4.1/4"	107,95	17.1/2"	444,5
13/16"	20,64	1.13/16"	46,04	4.1/2"	114,3	18"	457,2
27/32"	21,43	1.27/32"	46,83	4.3/4"	120,65	18.1/2"	469,9
7/8"	22,23	1.7/8"	47,63	5"	127	19"	482,6
29/32"	23,02	1.29/32"	48,42	5.1/4"	133,35	19.1/2"	495,3
15/16"	23,81	1.15/16"	49,21	5.1/2"	139,7	20"	508
31/32"	24,61	1.31/32"	50,01	5.3/4"	146,05	20.1/2"	520,7
1"	25,4	2"	50,8	6"	152,4	21"	533,4

CADEIRINHA FECHADA

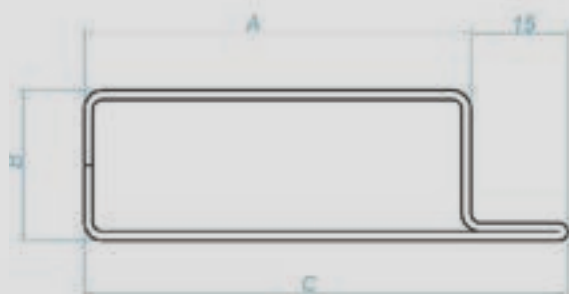

PERFIL #16

A	B	C	PESO
*200	25	215	16.40
*150	25	165	13.20
*120	25	135	10.80
*100	25	115	9.40
80	25	95	8.00
75	25	90	7.80
70	25	85	7.40
65	25	80	7.20
60	25	75	6.60
50	25	65	6.00
45	25	60	5.60
40	25	55	5.20
30	25	45	4.60
25	25	40	4.20

A	B	C	PESO
*200	30	215	16.80
*150	30	165	13.40
*120	30	135	11.20
*100	30	115	9.80
85	30	100	8.80
80	30	95	8.40
75	30	90	8.00
70	30	85	7.60
65	30	75	7.00
50	30	65	6.40
40	30	55	5.60
30	30	45	4.80
60	30	90	6.70

PERFIL TEE

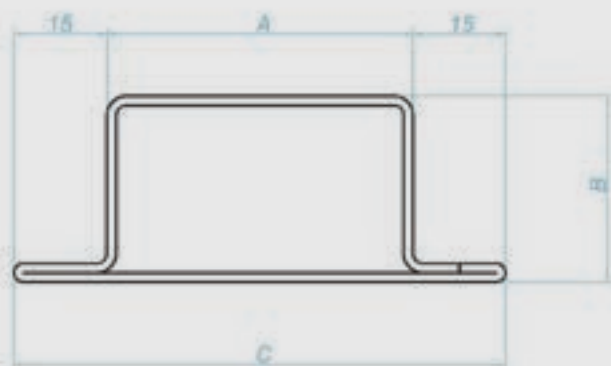

PERFIL #16

A	B	C	PESO
*80	30	110	9.40
50	30	80	7.40
*40	30	70	6.80
30	30	60	6.00
*25	30	55	5.80
*20	30	50	5.40
15	30	45	5.00

A	B	C	PESO
*80	25	110	9.00
*50	25	80	7.20
*40	25	70	6.20
30	25	60	5.60
25	25	55	5.40
*20	25	50	4.80
15	25	45	4.60



PERFIL ZEE

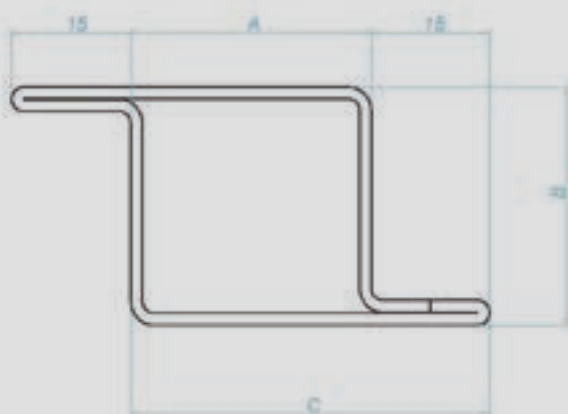

PERFIL #16

A	B	C	PESO
20	25	40	5.40
15	25	30	4.60

A	B	C	PESO
30	30	40	5.40
25	25	40	5.50

BATENTE RETO

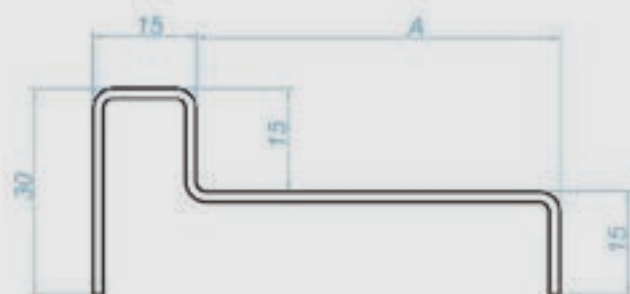

PERFIL #16

A	PESO
53	4.20
43	4.00
33	3.40
28	3.40

PERFIL #14

A	PESO
43	5.20
33	4.60
28	4.40

BATENTE MOLDURADO

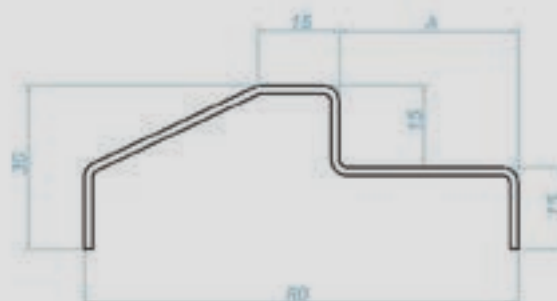

PERFIL #16

A	PESO
33	4.20



BATEDOR M

PERFIL #16

A	PESO
43	5.40
33	5.00
*28	4.80

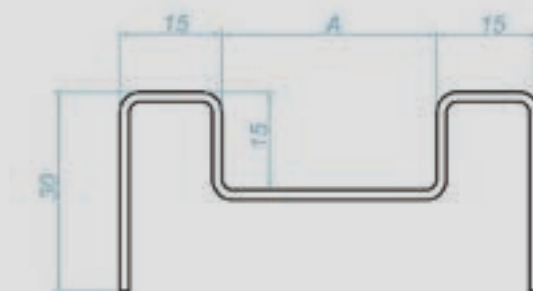

BATEDOR FECHADO

PERFIL #16

A	PESO
33	6.60
*28	6.20

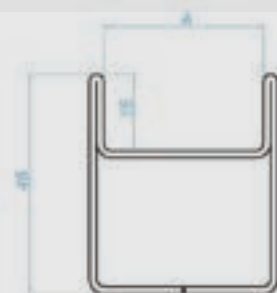

CAPA L

PERFIL #16

A	B	PESO
*20	180	6.80
*20	120	4.80
10	70	2.60

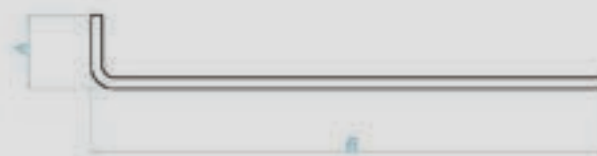

TRILHO STANLEY

PERFIL #16

PESO
7.40

PERFIL #14

PESO
9.80



TRILHO G

PERFIL #16

A	B	C	D	E	PESO
*10	50	50	40	10	5.20
10	50	50	30	10	5.00
*10	50	50	25	10	4.80

PERFIL #14

A	B	C	D	E	PESO
*10	50	50	40	10	7.20
10	50	50	30	10	6.60
*10	50	50	25	10	6.40

PERFIL #1/8

A	B	C	D	E	PESO
*20	100	150	50	15	23.00
*20	80	100	45	15	17.60

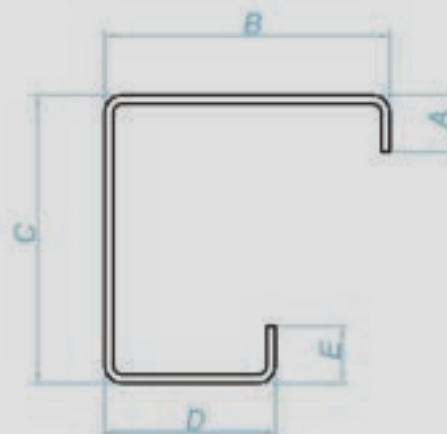

PERFIL U

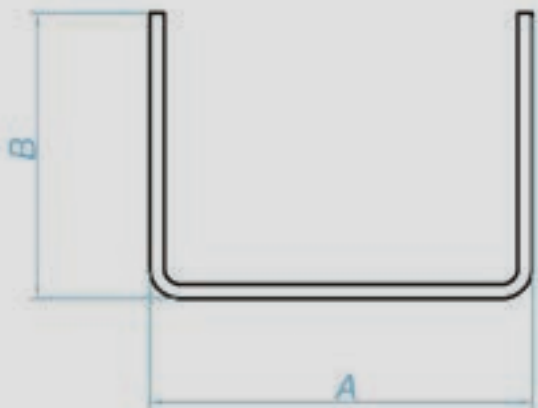

PERFIL #16

A	B	COMPRIMENTO	PESO
*30	80	3000mm	6.00
40	30	3000mm	3.20
*150	15	3000mm	6.20
*140	15	3000mm	5.80
*120	15	3000mm	5.00
*100	15	3000mm	4.40
*80	15	3000mm	2.60
*50	15	3000mm	2.20
*38	15	3000mm	2.00
20	10	3000mm	1.20
**20	10	2500mm	1.00
**28	28	3000mm	2.60
**25	25	3000mm	2.50

PERFIL U - ENRIJECIDO

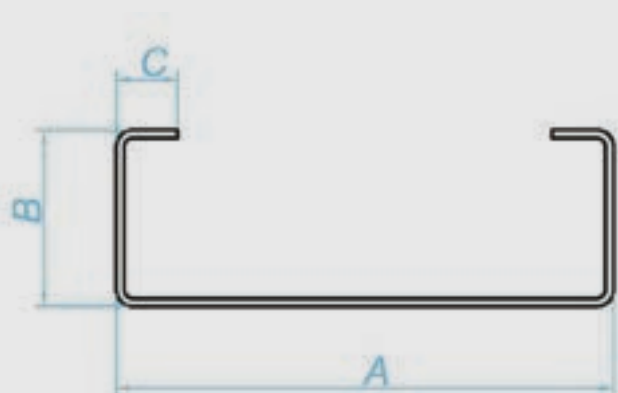

PERFIL #16

PESO

5.70

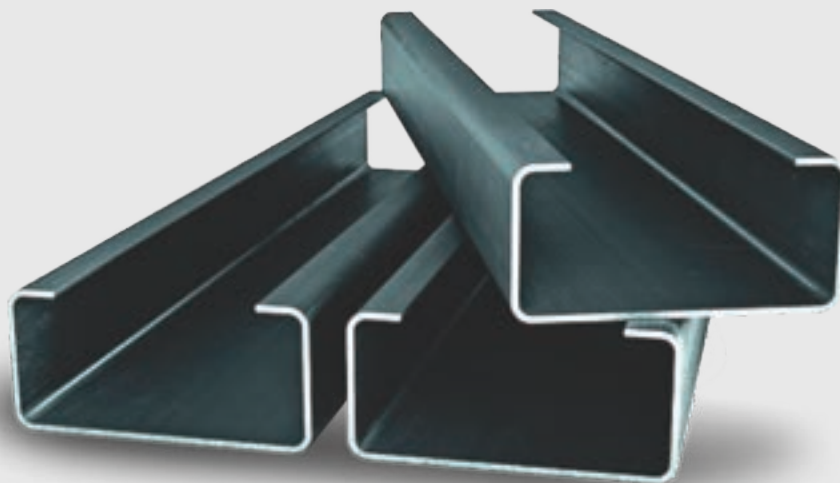

COLUNA FECHADA

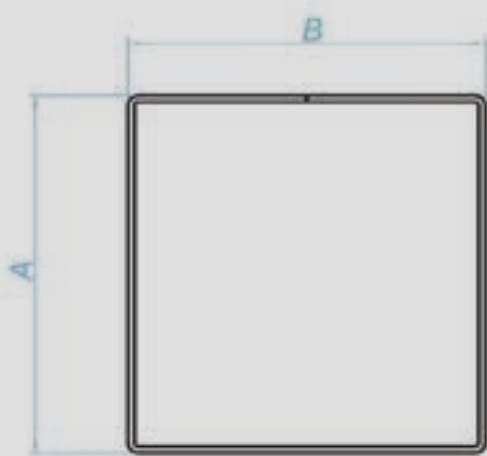

PERFIL #16

A	B	COMPRIMENTO	PESO
200	200	3000mm	28.00
*150	200	3000mm	24.00
120	200	3000mm	22.00
*100	200	3000mm	20.60
170	170	3000mm	23.30
120	170	3000mm	20.00
*100	170	3000mm	18.30
70	170	3000mm	16.30
150	150	3000mm	20.60
120	150	3000mm	18.60
*100	150	3000mm	17.00
140	140	3000mm	19.30
**130	130	3000mm	17.80
120	120	3000mm	16.30
**80	120	3000mm	13.30

BATEDOR EM GRAU

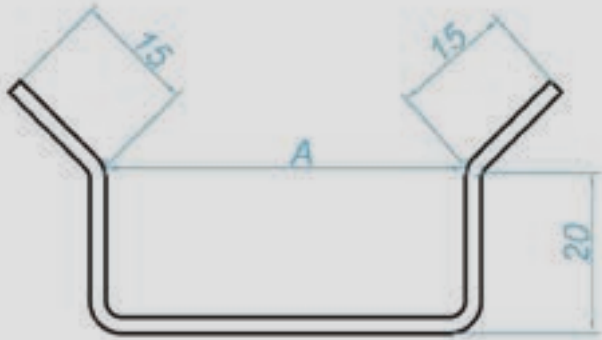

PERFIL #14

A	PESO
45	5.30
35	4.80

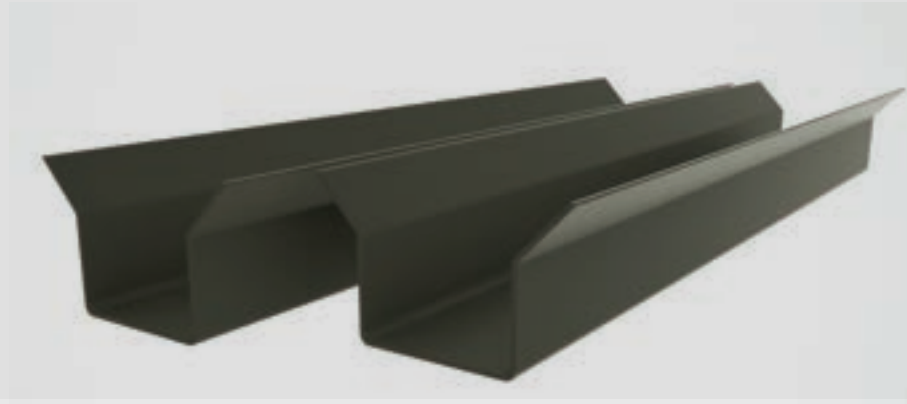

ZEE SIMPLES

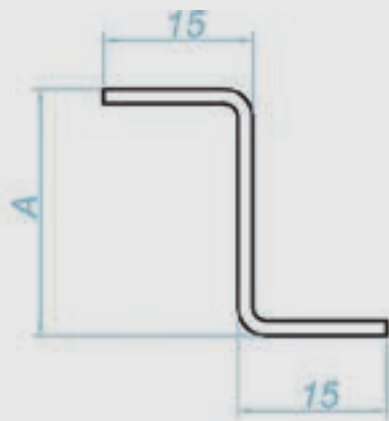

PERFIL #16

A	PESO
25	1.80

PERFIL #14

A	PESO
25	2.50

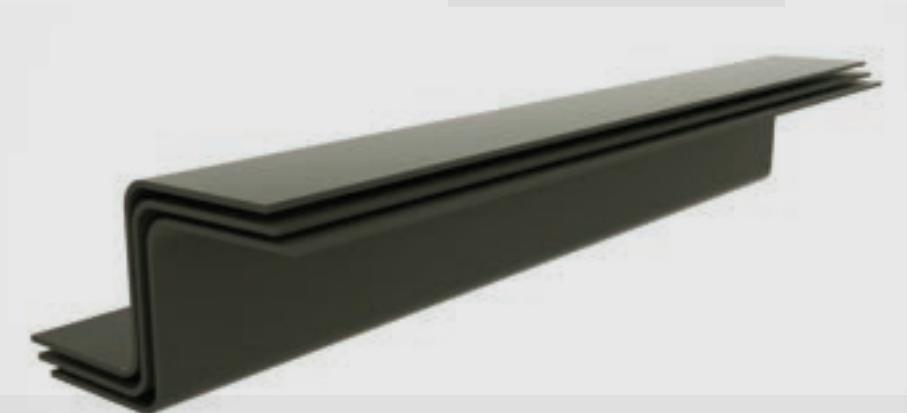

PAINEL REDONDO

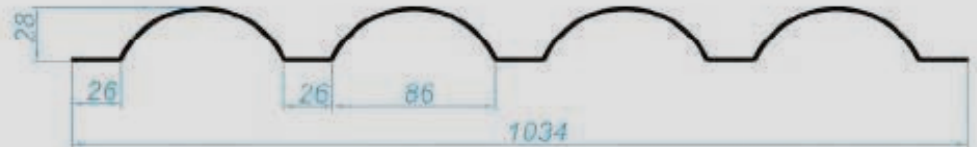

PERFIL #18

COMPRIMENTO	PESO
3000mm	34.00
2500mm	28.00
2300mm	26.00
2000mm	22.60

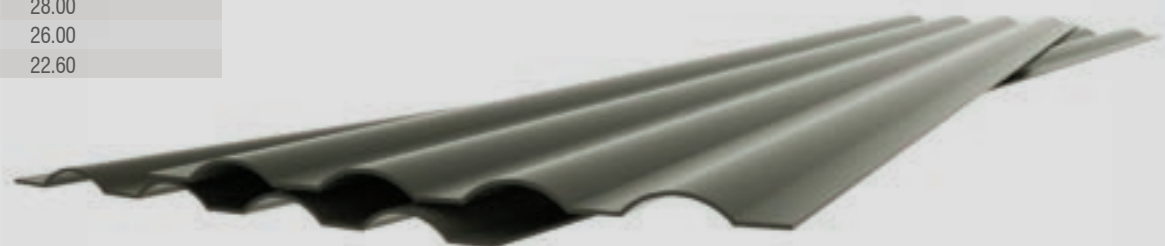

LAMBRIL REDONDO

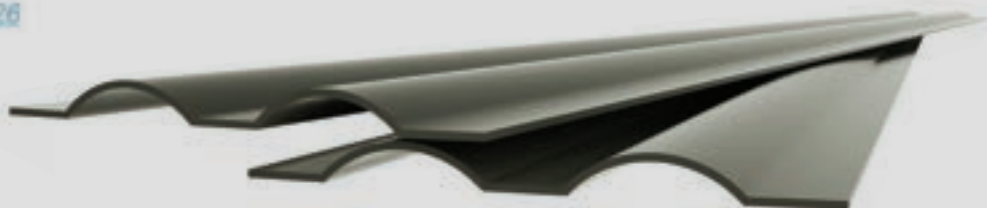
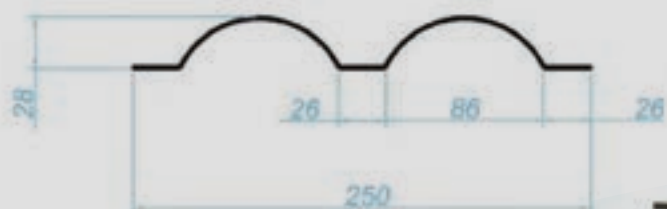

PERFIL #18

COMPRIMENTO	PESO
3000mm	8.20
2500mm	6.90
2300mm	6.40
2000mm	5.50

COMPLEMENTO REDONDO

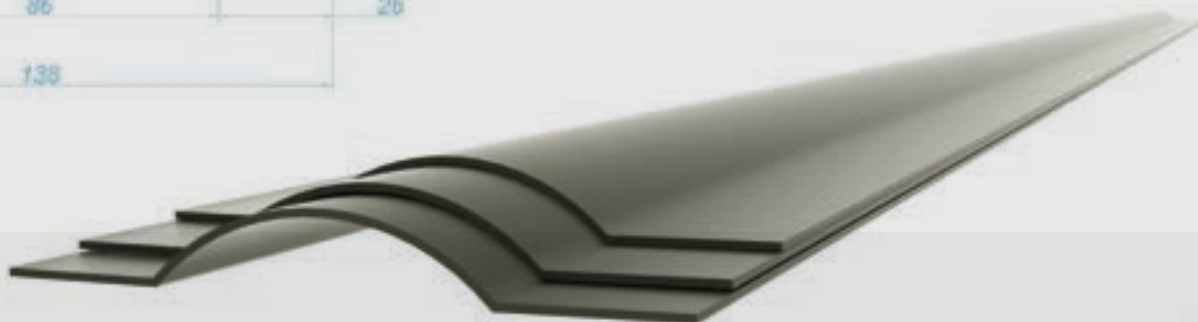

PERFIL #18

COMPRIMENTO	PESO
3000mm	4.20
2500mm	3.50
2300mm	3.30
2000mm	2.80

PAINEL QUADRADO

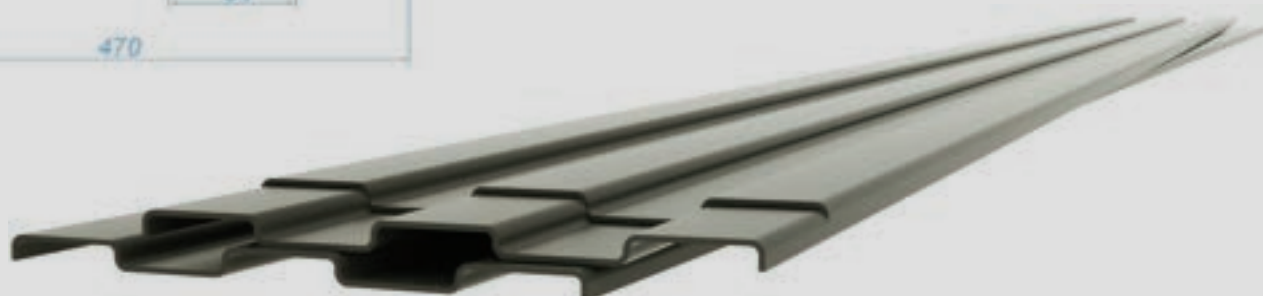
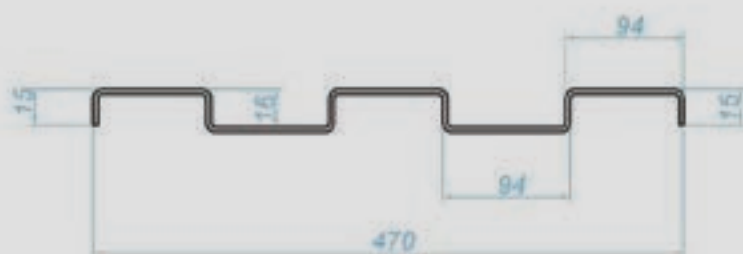

PERFIL #18

COMPRIMENTO	PESO
3000mm	15.60
2500mm	13.00
2300mm	12.00
2000mm	10.40

PAINEL QUADRADO

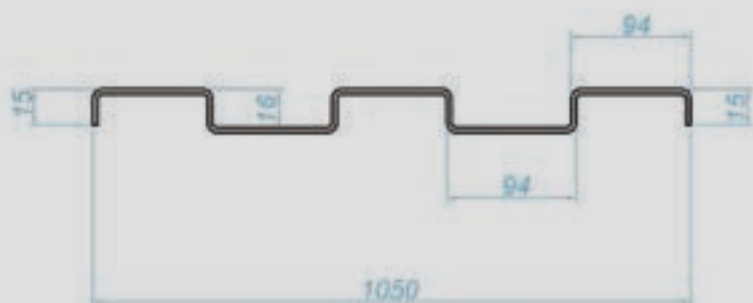

PERFIL #18

COMPRIMENTO	PESO
3000mm	34.00
2500mm	28.00
2300mm	26.00
2000mm	22.60



COMPLEMENTO QUADRADO

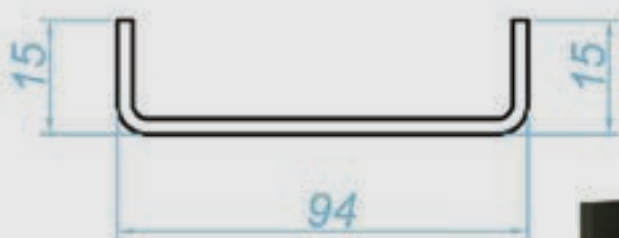

PERFIL #18

COMPRIMENTO	PESO
*3000mm	3.40
*2500mm	2.90
*2300mm	2.65
*2000mm	2.30



LAMBRIL QUADRADO

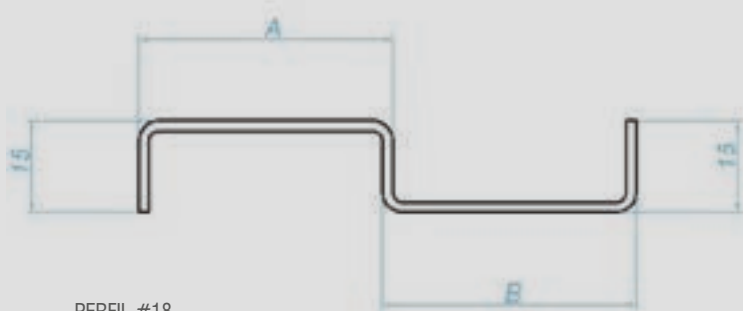

PERFIL #18

A	B	COMPRIMENTO	PESO
150	50	3000mm	6.80
80	40	3000mm	4.40
80	40	2500mm	3.60
80	40	2300mm	3.40
80	40	2000mm	3.00
94	94	2000mm	4.30
*94	94	2300mm	5.05
*94	94	2500mm	5.45
94	94	3000mm	6.50

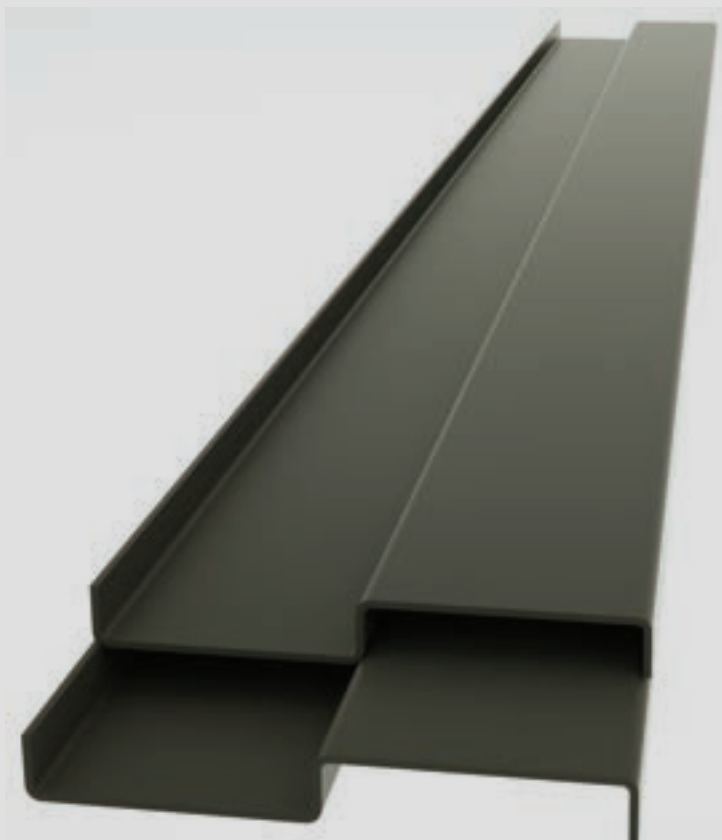

PALHETA FECHADA

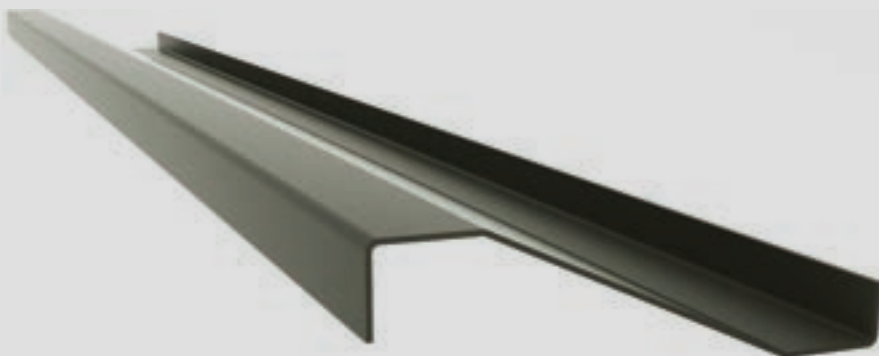

PERFIL #18

A	B	COMPRIMENTO	PESO
*27	25	3000mm	3.00
*27	25	2500mm	2.50
*27	25	2300mm	2.30
*27	25	2000mm	2.00
22	20	3000mm	3.00
*22	20	2500mm	2.50
*22	20	2300mm	2.30
*22	20	2000mm	2.00

PALHETA ABERTA



PERFIL #18

A	COMPRIMENTO	PESO
27	3000mm	2.80
27	2500mm	2.40
27	2300mm	2.25
27	2000mm	2.00
22	3000mm	2.80
22	2500mm	2.40
22	2300mm	2.25
22	2000mm	2.00

PALHETA AMASSADA

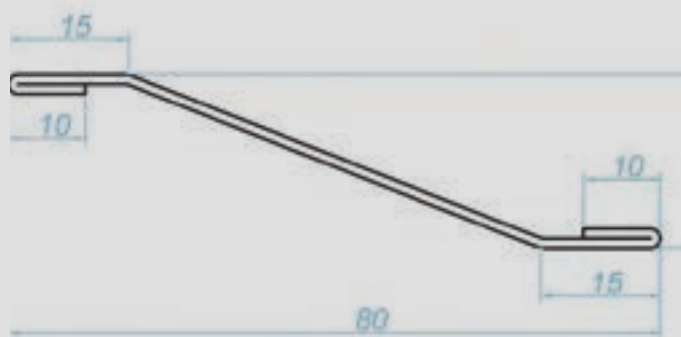

PERFIL #18

COMPRIMENTO	PESO
3000mm	2.80
2500mm	2.33
2300mm	2.25
2000mm	1.90



CAIXA ABERTA

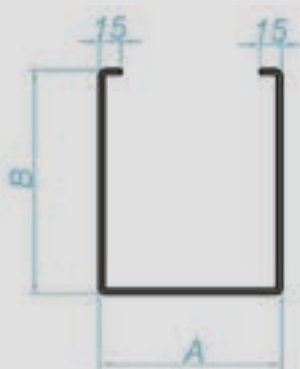
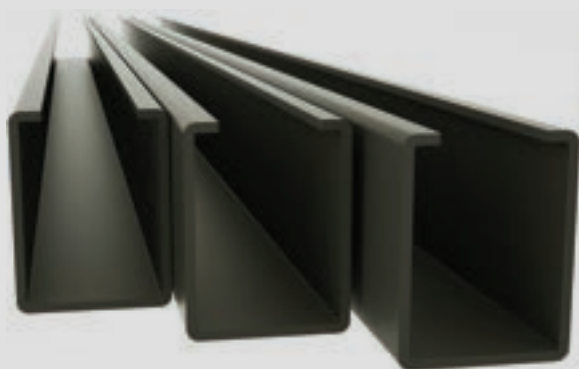

PERFIL #16

A	B	COMPRIMENTO	PESO
*200	200	3000mm	21.00
*200	200	2500mm	17.66
*150	200	3000mm	20.00
*150	200	2500mm	16.66
*100	200	3000mm	18.00
*100	200	2500mm	15.00
*170	170	3000mm	18.40
*170	170	2500mm	15.33
*150	150	3000mm	16.00
*150	150	2500mm	13.33
**100	150	3000mm	15.20
**100	150	2500mm	12.66

** Fabricação sob consulta.
* Fina Fria e Galvanizada.

TRILHO BASCULANTE

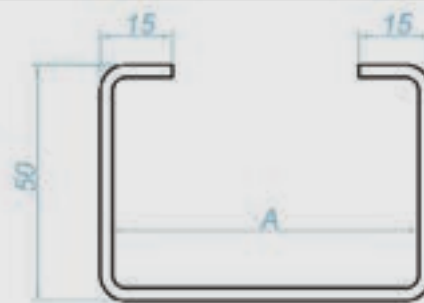

PERFIL #12

A	COMPRIMENTO	PESO
65	3000mm	12.20
65	2500mm	9.40
49	3000mm	10.40
49	2500mm	8.60

TAMPA CARTOLA

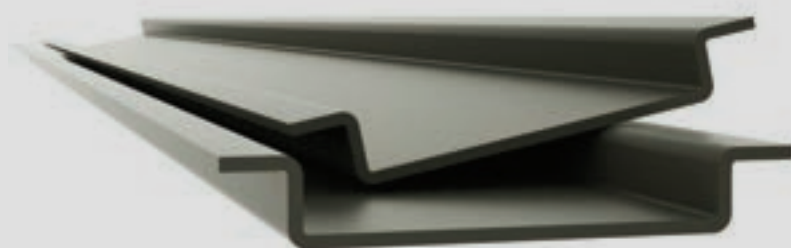

PERFIL #16

A	COMPRIMENTO	PESO
*170	3000mm	8.40
*170	2500mm	7.00
*140	3000mm	6.80
*140	2500mm	5.66
*120	3000mm	6.30
*120	2500mm	5.33
*70	3000mm	4.40
*70	2500mm	3.66

TELHA ONDULADA 17

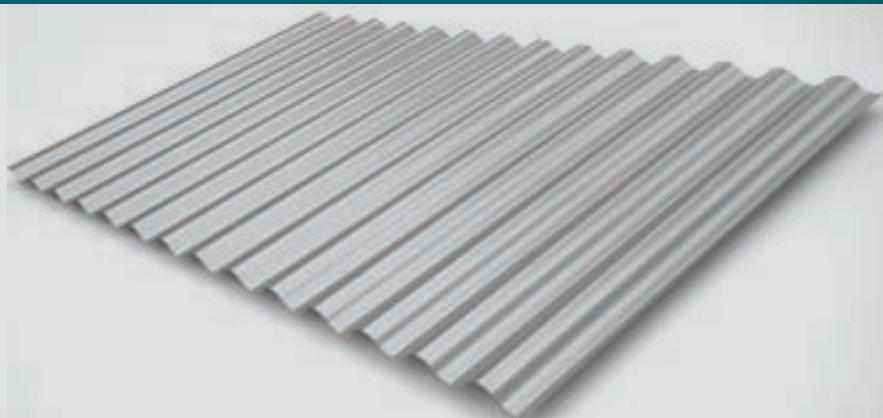
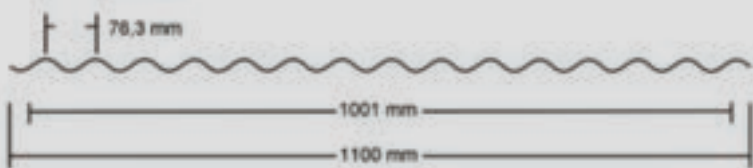

TELHA TRAPÉZIO 25, 35 e 40

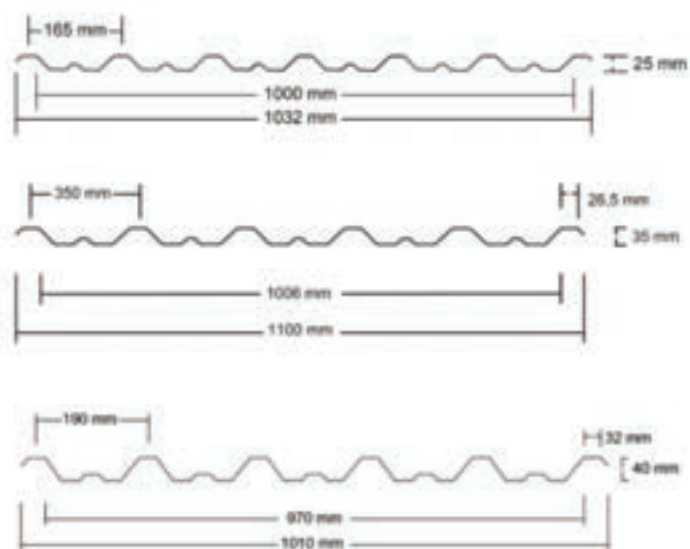

CUMEEIRAS

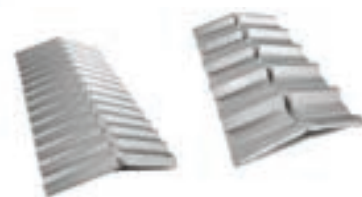

BOBININHAS GALVANIZADAS



ESPESSURA mm	LARGURA mm
0.50	1200
0.50	1100
0.50	1000
0.50	800
0.50	700
0.50	650
0.50	600
0.50	550
0.50	500
0.50	450
0.50	400
0.50	350
0.50	330
0.50	300
0.50	280
0.50	250
0.50	220
0.50	200
0.50	150
0.50	100

BELINOX

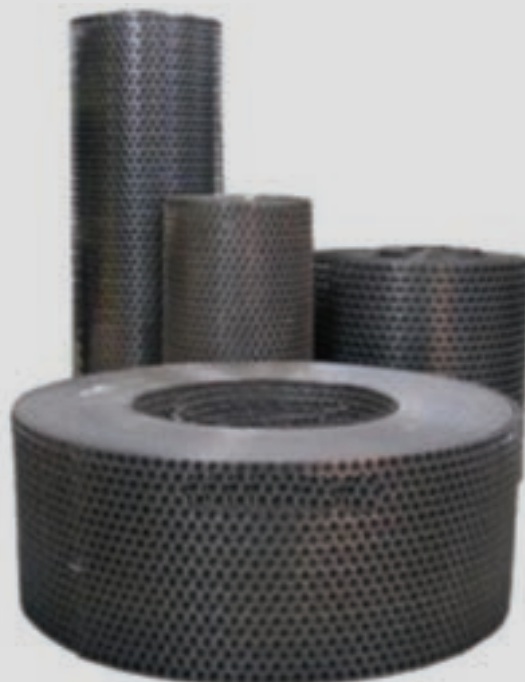

MÁQUINAS E FERRAMENTAS

PARA DIVERSOS TIPOS DE SERVIÇOS



FORÇADO AÇO

DISTRIBUIÇÃO, CORTE E DOBRA



PARAFUSADEIRAS E FURADEIRAS



MÁQUINAS E FERRAMENTAS

PARA DIVERSOS TIPOS DE SERVIÇOS

ESMERILHADEIRA

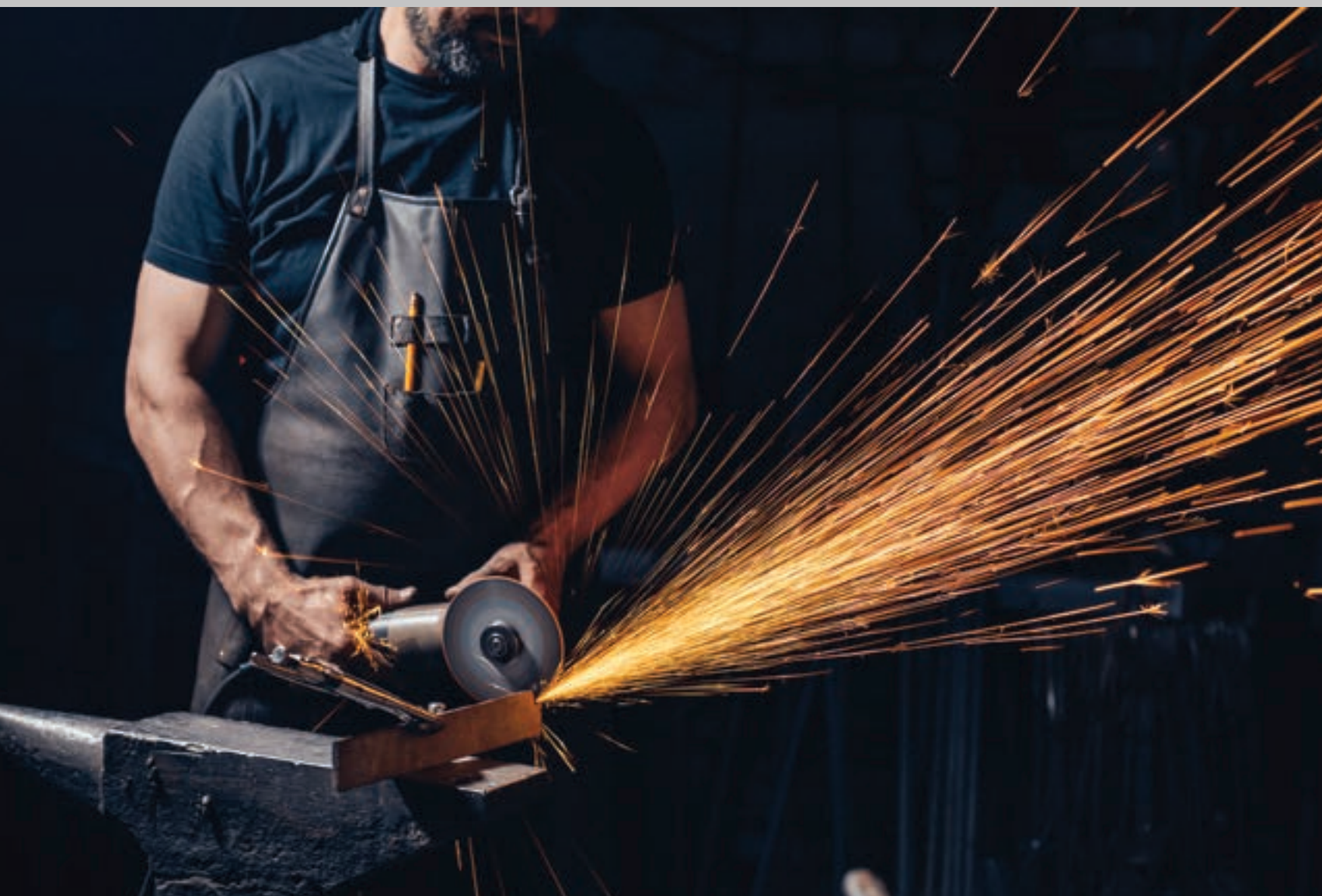

MÁQUINAS E FERRAMENTAS

PARA DIVERSOS TIPOS DE SERVIÇOS



FORÇADO AÇO

DISTRIBUIÇÃO, CORTE E DOBRA

FERRAMENTAS DIVERSAS



MÁQUINAS E FERRAMENTAS

PARA DIVERSOS TIPOS DE SERVIÇOS



SOLDADORAS



ACESSÓRIOS

DIVERSOS



Alavanca Basculante



Caixa com mola



Disco Corte e Desbaste



Dobradiças



Fecho maxim

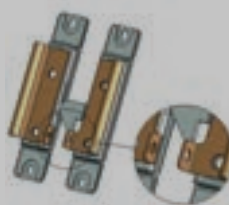

Fecho automático



Fechaduras



Fita de Aço - Mola



Roldanas

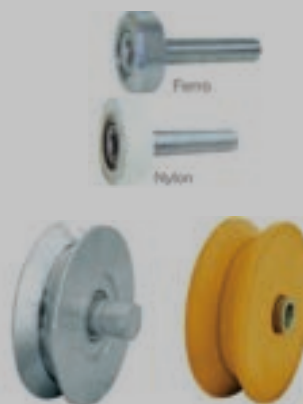

Puxador Janela



Puxador para Porta



Eletrodos



Rebite Repuxo



Ponta de Lança

CURVAS E ACESSÓRIOS PARA CORRIMÕES













































FORÇADO AÇO

DISTRIBUIÇÃO, CORTE E DOBRA

CURVAS

ACESSÓRIOS

MODELO DA CURVA	BITOLA	COD.	ACESSÓRIOS	BITOLA	FURO	COD.	ACESSÓRIOS	BITOLA	COD.			
 COTOVELO	1"	10.91	 ARRUELA COM REPUXO	3"	1 1/4"	28.30	 ARRUELA LISA	3"	28.10			
	1 1/2"	14.91			1 1/2"	28.31		3 1/2"	28.15			
	1 3/4"	12.91		3 1/2"	1 3/4"	28.32	 COM FURO	 SEM FURO	4"	28.20		
	1 3/4"	13.91			1 1/2"	28.33						
	2"	20.91			1 3/4"	28.35						
	3"	30.03		4"	2"	28.34	 SUPORE DE CORRIMÃO		3"	28.70		
	4"	40.04			1 1/2"	28.40						
 COTOVELO COM LUVA	1 1/2"	12.92	 CANOPLA DE ACABAMENTO	3"	20x20	28.80	 ARRUELA SEM FURO	1 1/4"	28.03			
	2"	20.92			20x30	28.84		1 1/2"	28.04			
25x25					28.85	1 3/4"		28.05				
 PONTA DE CORRIMÃO	1 1/2"	14.93		3 1/2"	30x30	28.81		 ESPAÇADOR	1 1/4"	30.01		
	1 1/2"	12.93			40x40	28.82			1 1/2"	30.02		
	1 3/4"	13.93			30x30	28.90	1 3/4"		30.03			
 CURVA 45°	2"	20.93		4"	40x40	28.91	 SUPORE DE CORRIMÃO EM "L"	2"	30.04			
	1 1/2"	14.45	50x50		28.92				28.71			
	1 1/2"	12.45	1/2"		28.49							
 CURVA 135°	1 3/4"	13.45	 CANOPLA DE ACABAMENTO	3"	1"	28.48	 CANOPLA DE ACABAMENTO PARA SUPORE DE CORRIMÃO	3"	28.52			
	2"	20.45			1 1/4"	28.51						
	 CURVA 65°	1 1/2"		14.65	3 1/2"	1 1/2"				28.53		
1 1/2"		12.65		1 3/4"		28.56						
1 3/4"		13.65		2"		28.55						
 CURVA 90°	2"	20.65		4"	1 1/2"	28.60					3"	28.52
	2 1/2"	25.65			1 3/4"	28.63						
 CURVA 90°	1"	03.90	 CANOPLA DE ACABAMENTO QUADRADA	85X85	20x20	29.20	 BASE QUADRADA	80X80	x	28.00		
	7/8"	07.90			20x30	29.21						
	1"	10.90			25x25	29.25						
	1 1/4"	14.90			30x30	29.30						
	1 1/2"	12.90			40x40	29.40						
	1 3/4"	13.90			50x50	29.50						
	2"	20.90										
	2 1/2"	25.90										
 CURVA 115°	3"	30.90										
	1 1/2"	14.115										
	1 1/2"	12.115										
	1 3/4"	13.115										
2"	20.115											
2 1/2"	25.115											
 CURVA 180°	1"	10.180										
	1 1/2"	14.180										
	1 3/4"	12.180										
	1 3/4"	13.180										
	2"	20.180										
	2 1/2"	25.180										
3"	30.180											



CORTE E DOBRA

COMPRIMENTO DE ATÉ 6M | ESPESSURA DE ATÉ 3/8 OU 10MM



FORÇADO AÇO

DISTRIBUIÇÃO, CORTE E DOBRA

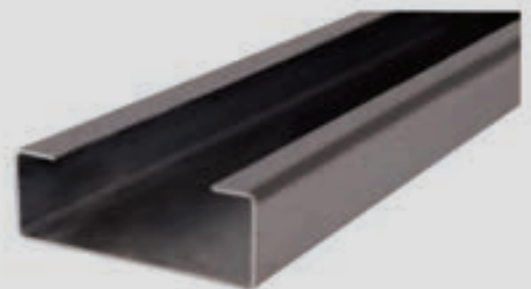
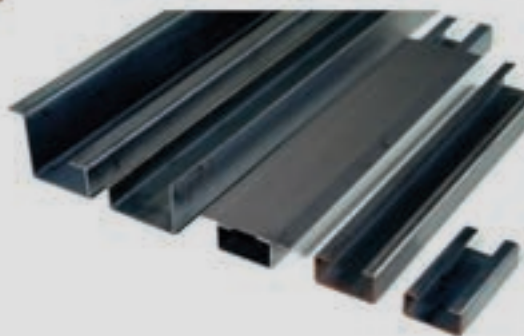

FABRICAÇÃO DE PEÇAS PARA MÁQUINAS E IMPLEMENTOS AGRÍCOLAS



FORÇADO AÇO
DISTRIBUIÇÃO, CORTE E DOBRA



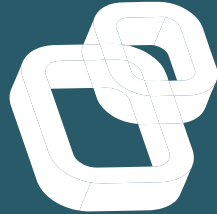

FORÇADO AÇO

DISTRIBUIÇÃO, CORTE E DOBRA

44 **3523-2226**

44 **9.9165-4811**

44 **9.9128-3224**

44 **9.9180-7203**

44 **9.9102-3634**

Av. Comendador Norberto Marcondes, 493
Campo Mourao. Pr. CEP 87302-060

forcadoaco@forcadoaco.com.br
www.forcadoaco.com.br